

TC75 USER GUIDE

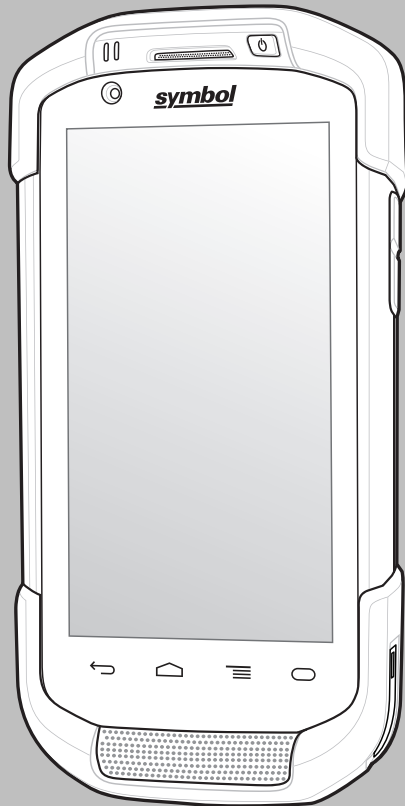

Copyrights

The products described in this document may include copyrighted computer programs. Laws in the United States and other countries preserve for certain exclusive rights for copyrighted computer programs. Accordingly, any copyrighted computer programs contained in the products described in this document may not be copied or reproduced in any manner without the express written permission.

© 2015 Symbol Technologies LLC. All Rights Reserved

No part of this document may be reproduced, transmitted, stored in a retrieval system, or translated into any language or computer language, in any form or by any means, without the prior written permission.

Furthermore, the purchase of our products shall not be deemed to grant either directly or by implication, estoppel or otherwise, any license under the copyrights, patents or patent applications, except for the normal non-exclusive, royalty-free license to use that arises by operation of law in the sale of a product.

Disclaimer

Please note that certain features, facilities, and capabilities described in this document may not be applicable to or licensed for use on a particular system, or may be dependent upon the characteristics of a particular mobile subscriber unit or configuration of certain parameters. Please refer to your contact for further information.

Trademarks

Zebra and the Zebra head graphic are registered trademarks of ZIH Corp. The Symbol logo is a registered trademark of Symbol Technologies LLC.

Revision History

Changes to the original guide are listed below:

Change	Date	Description
A01 Rev. A	5/2015	Initial release.
A02 Rev. A	8/2015	Add support for Google Mobile Services.

Contents

Copyrights.....	3
Revision History.....	5
About This Guide.....	13
Documentation Set.....	13
Configurations.....	13
Software Versions.....	14
Chapter Descriptions.....	14
Notational Conventions.....	14
Icon Conventions.....	15
Related Documents.....	15
Service Information.....	15
Chapter 1: Getting Started.....	17
Unpacking.....	17
Features.....	18
Setup.....	20
Installing the SIM Card.....	20
Installing the SAM Card.....	21
Installing a microSD Card.....	22
Installing the Hand Strap and Battery.....	23
Installing the Battery.....	24
Charging the Battery.....	25
Charging Indicators.....	26
Google Account Setup.....	26
Replacing the Battery.....	26
Replacing the SIM or SAM Card.....	28
Replacing the microSD Card.....	31
Battery Management.....	32
Monitor Battery Usage.....	32
Low Battery Notification.....	33
Battery Optimization.....	33
Turning Off the Radios.....	33
Setting the Date and Time.....	33
Display Setting.....	34
Setting the Screen Brightness.....	34
Setting Screen Rotation.....	34
Setting Screen Timeout Setting.....	35
Setting Font Size.....	35
Setting Touch Key Light.....	35
Touch Mode.....	36
Setting Notification LED.....	37
General Sound Setting.....	37
Wake-Up Sources.....	40
Chapter 2: Using the TC75.....	41
Google Mobile Services.....	41
Home Screen.....	41
Status Bar.....	43
Status Icons.....	43

Notification Icons.....	44
Managing Notifications.....	45
Quick Settings.....	46
Application Shortcuts and Widgets.....	47
Adding an Application or Widget to the Home Screen.....	47
Moving Items on the Home Screen.....	48
Removing an App or Widget from the Home Screen.....	48
Folders.....	48
Creating a Folder.....	48
Naming Folders.....	48
Removing a Folder.....	49
Home Screen Wallpaper.....	49
Changing the Home Screen Wallpaper.....	49
Using the Touchscreen.....	49
Using the On-screen Keyboard.....	50
Applications.....	50
Accessing Applications.....	54
Switching Between Recent Applications.....	55
Un-Locking the Screen.....	55
Single User Mode.....	55
MultiUser Mode.....	58
MultiUser Login.....	58
MultiUser Logout.....	59
Resetting the Device.....	59
Performing a Soft Reset.....	59
Performing a Hard Reset.....	59
Suspend Mode.....	60

Chapter 3: Calls.....61

Making a Call Using the Dialer.....	62
Dialer Dialing Options.....	64
Making a Call Using Contacts.....	65
Making a Call Using Call History.....	65
Making a Conference Call.....	66
Making a Call Using a Bluetooth Headset.....	68
Answering Calls.....	68
Answering Calls with a Bluetooth Headset.....	70
Call Settings.....	70

Chapter 4: Applications.....73

File Browser.....	73
Messaging.....	74
Sending a Text Message.....	74
Sending a Multimedia Message.....	75
People.....	75
Adding People.....	76
Editing People.....	76
Deleting People.....	76
Camera.....	76
Taking Photos.....	77
Taking a Panoramic Photo.....	79
Recording Videos.....	80
Photo Settings.....	82
Video Settings.....	84

Gallery.....	85
Working with Albums.....	86
Share an Album.....	87
Get Album Information.....	87
Deleting an Album.....	88
Working with Photos.....	88
Viewing and Browsing Photos.....	88
Cropping a Photo.....	89
Setting a Photo as a Contact Icon.....	90
Share a Photo.....	90
Deleting a Photo.....	91
Working with Videos.....	91
Watching Videos.....	91
Sharing a Video.....	92
Deleting a Video.....	92
DataWedge Demonstration.....	93
Sound Recorder.....	94
PTT Express Voice Client.....	95
Enabling PTT Communication.....	96
Selecting a Talk Group.....	96
PTT Communication.....	96
Creating a Group Call.....	97
Disabling PTT Express Voice Client Communication.....	97
MLog Manager.....	97
SimulScan Demo.....	98
Exporting Sample Forms.....	99
Postal, Transportation and Logistics Example.....	99
Manufacturing Example.....	101
Settings.....	102
Advanced Settings.....	103
Demo Customization.....	103
Default Templates.....	104
RxLogger.....	105
Elemez.....	105
Disabling Elemez Data Collection.....	106
Enabling Elemez Data Collection.....	106

Chapter 5: Data Capture..... 109

Imaging.....	109
Digital Camera.....	109
RS507 Hands-Free Imager.....	110
Scanning Considerations.....	110
Imager Scanning.....	110
Bar Code Capture with Integrated Camera.....	112
Bar Code Capture with RS507 Hands-Free Imager.....	112
Pairing the RS507 Hands-Free Imager Bluetooth HID.....	114
DataWedge.....	114
Enabling DataWedge.....	114
Disabling DataWedge.....	115

Chapter 6: Wireless..... 117

Wireless Wide Area Networks.....	117
Sharing the Mobile Data Connection.....	117
USB Tethering.....	117

Bluetooth Tethering.....	118
Portable Wi-Fi Hotspot.....	118
Data Usage.....	119
Disabling Data When Roaming.....	120
Limiting Data Connection to 2G Networks.....	121
Locking the SIM Card.....	121
Editing the Access Point Name.....	122
Wireless Local Area Networks.....	122
Scan and Connect to a Wi-Fi Network.....	122
Configuring a Wi-Fi Network.....	124
Manually Adding a Wi-Fi Network.....	126
Configuring for a Proxy Server.....	126
Configuring the Device to Use a Static IP Address.....	127
Advanced Wi-Fi Settings.....	128
Remove a Wi-Fi Network.....	129
Bluetooth.....	130
Adaptive Frequency Hopping.....	130
Security.....	130
Bluetooth Profiles.....	131
Bluetooth Power States.....	131
Bluetooth Radio Power.....	131
Enabling Bluetooth.....	131
Disabling Bluetooth.....	132
Discovering Bluetooth Device(s).....	132
Changing the Bluetooth Name.....	133
Connecting to a Bluetooth Device.....	133
Selecting Profiles on the Bluetooth Device.....	133
Unpairing a Bluetooth Device.....	134
Near Field Communications.....	134
Reading NFC Cards.....	134
Sharing Information Using NFC.....	135
Enterprise NFC Settings.....	136

Chapter 7: Accessories..... 139

Accessories.....	139
2-Slot Charge Only Cradle.....	141
Charging the Device.....	142
Charging the Spare Battery.....	143
Battery Charging.....	144
2-Slot USB/Ethernet Cradle.....	144
Charging the Device.....	145
Charging the Spare Battery.....	146
Battery Charging.....	147
USB/Ethernet Communication.....	148
Establishing Ethernet Connection.....	149
5-Slot Charge Only Cradle.....	149
Charging the TC75.....	150
Battery Charging.....	151
5-Slot Ethernet Cradle.....	152
Charging the TC75.....	153
Battery Charging.....	155
Establishing Ethernet Connection.....	155
LED Indicators.....	156
4-Slot Battery Charger.....	156
Charging Spare Batteries.....	156

Battery Charging.....	157
Magnetic Stripe Reader.....	157
Attaching the MSR.....	157
Removing the MSR.....	158
Reading Magnetic Stripe Cards.....	159
2.5 mm Audio Adapter.....	160
Attaching the 2.5 mm Audio Adapter.....	160
Connecting a Headset to the Audio Adapter.....	161
Device with Audio Adapter in Holster.....	162
Removing the 2.5 mm Audio Adapter.....	163
3.5 mm Audio Adapter.....	163
Connecting a Headset to the 3.5 mm Audio Adapter.....	164
Attaching the 3.5 mm Audio Adapter.....	164
Device with 3.5 mm Audio Adapter in Holster.....	165
Removing the 3.5 mm Audio Adapter.....	166
Snap-On USB Cable.....	166
Connecting to TC75.....	166
USB Communication.....	167
Charging the TC75.....	167
Disconnecting from TC75.....	168
Battery Charging.....	169
Charging Cable Cup.....	169
Charging the TC75.....	169
Battery Charging.....	171
Snap-On DEX Cable.....	171
Connecting to TC75.....	172
DEX Communication.....	172
Disconnecting from TC75.....	173
Trigger Handle.....	174
Installing the Trigger Handle Plate.....	174
Inserting the Device into the Trigger Handle.....	175
Removing the Device from the Trigger Handle.....	176
Vehicle Charging Cable Cup.....	177
Charging the TC75.....	178
Battery Charging.....	180
Vehicle Cradle.....	180
Chapter 8: Maintenance and Troubleshooting.....	183
Maintaining the TC75.....	183
Battery Safety Guidelines.....	183
Cleaning Instructions.....	184
Cleaning the TC75.....	185
Connector Cleaning.....	185
Cleaning Cradle Connectors.....	185
Troubleshooting.....	186
TC75.....	186
Chapter 9: Technical Specifications.....	189
TC75.....	189

About This Guide

Introduction

This guide provides information about using the TC75 mobile computer and accessories.



Note: Screens and windows pictured in this guide are samples and can differ from actual screens.

Documentation Set

The documentation set for the TC75 provides information for specific user needs, and includes:

- *TC75 Quick Start Guide* - describes how to get the TC75 up and running.
- *TC75 User Guide* - describes how to use the TC75.
- *TC75 Integrator Guide* - describes how to set up the TC75 and accessories.



Configurations

This guide covers the following configurations:



Configuration	Radios	Display	Memory	Data Capture Options	Operating System
TC75AH Professional (without Google Mobile Services (GMS))	WWAN: LTE WLAN: 802.11 a/b/g/n/d/h/i/k/r WPAN: Bluetooth v4.0 Low Energy	4.7" High Definition (1280 x 720) LCD	1 GB RAM / 8 GB Flash (SLC High Reliability Flash)	2D imager and integrated NFC	Android-based, Android Open-Source Project 4.4.3.
TC75BH Professional (without Google Mobile Services (GMS))	WWAN: HSPA+ WLAN: 802.11 a/b/g/n/d/h/i/k/r WPAN: Bluetooth v4.0 Low Energy	4.7" High Definition (1280 x 720) LCD	1 GB RAM / 8 GB Flash (SLC High Reliability Flash)	2D imager and integrated NFC	Android-based, Android Open-Source Project 4.4.3.
TC75AH Standard (with GMS)	WWAN: LTE WLAN: 802.11 a/b/g/n/d/h/i/k/r WPAN: Bluetooth v4.0 Low Energy	4.7" High Definition (1280 x 720) LCD	1 GB RAM / 8 GB Flash (SLC High Reliability Flash)	2D imager and integrated NFC	Android-based, Android Open-Source Project 4.4.3 with GMS.
TC75BH Standard (with GMS)	WWAN: HSPA+	4.7" High Definition (1280 x 720) LCD	1 GB RAM / 8 GB Flash (SLC	2D imager and integrated NFC	Android-based, Android Open-

Configuration	Radios	Display	Memory	Data Capture Options	Operating System
	WLAN: 802.11 a/b/g/n/d/h/i/k/r		High Reliability Flash)		Source Project 4.4.3 with GMS.
	WPAN: Blue- tooth v4.0 Low Energy				

Software Versions

To determine the current software versions touch  >  **About phone**.

- **Model number**- Displays the model number.
- **Android version** - Displays the operating system version.
- **Kernel version** - Displays the kernel version number.
- **Build number** - Displays the software build number.

To determine the device serial number touch  >  **About phone** > **Status**.

- **Serial number** - Displays the serial number.

Chapter Descriptions

Topics covered in this guide are as follows:

- *Getting Started on page 17* provides information on getting the TC75 up and running for the first time.
- *Using the TC75 on page 41* provides information for operating the TC75.
- *Calls on page 61* provides instructions for making phone calls.
- *Applications on page 73* provides information on using applications installed on the TC75.
- *Data Capture on page 109* provides information for capturing bar code data using the imager.
- *Wireless on page 117* provides information on the various wireless options.
- *Accessories on page 139* provides information for using the accessories for the TC75.
- *Maintenance and Troubleshooting on page 183* includes instructions on cleaning and provides troubleshooting solutions for potential problems during TC75 operation.
- *Technical Specifications on page 189* provides the technical specifications for the TC75.

Notational Conventions

The following conventions are used in this document:

- *Italics* are used to highlight the following:
 - Chapters and sections in this and related documents
 - Icons on a screen.
- **Bold** text is used to highlight the following:
 - Dialog box, window, and screen names
 - Drop-down list and list box names

- Check box and radio button names
- Button names on a screen.
- Bullets (•) indicate:
 - Action items
 - Lists of alternatives
 - Lists of required steps that are not necessarily sequential
- Sequential lists (for example, lists that describe step-by-step procedures) appear as numbered lists.

Icon Conventions

The documentation set is designed to give the reader more visual clues. The following graphic icons are used throughout the documentation set. These icons and their associated meanings are described below.



Warning: The word WARNING with the associated safety icon implies information that, if disregarded, could result in death or serious injury, or serious product damage.



Caution: The word CAUTION with the associated safety icon implies information that, if disregarded, may result in minor or moderate injury, or serious product damage.



Note: NOTE contains information more important than the surrounding text, such as exceptions or preconditions. They also refer the reader elsewhere for additional information, remind the reader how to complete an action (when it is not part of the current procedure, for instance), or tell the reader where something is located on the screen. There is no warning level associated with a note.

Related Documents

- *TC75 Quick Start Guide*, p/n MN001727Axx.
- *TC75 Regulatory Guide*, p/n MN001704Axx.
- *TC75 Integrator Guide*, p/n MN001975Axx.

For the latest version of this guide and all guides, go to: <http://www.zebra.com/support>.

Service Information

If you have a problem with the equipment, contact Customer Support in the region. Contact information is available at: <http://www.zebra.com/support>.

When contacting support, please have the following information available:

- Serial number of the unit (found on manufacturing label)
- Model number or product name (found on manufacturing label)
- Software type and version number

Figure 1: Manufacturing Label

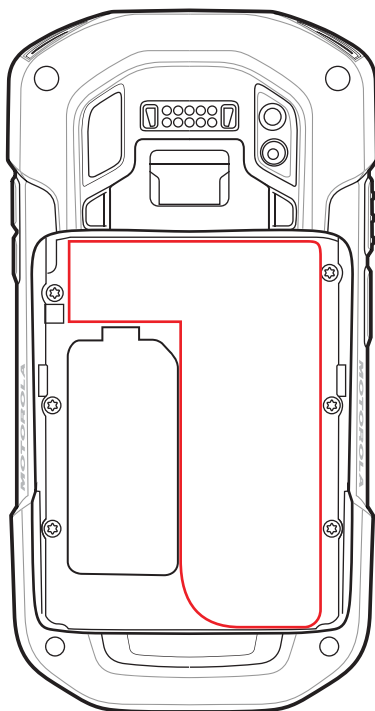

Customer Support responds to calls by email or telephone within the time limits set forth in support agreements.

If the problem cannot be solved by Customer Support, the user may need to return the equipment for servicing and will be given specific directions. We are not responsible for any damages incurred during shipment if the approved shipping container is not used. Shipping the units improperly can possibly void the warranty. Remove the microSD card from the device before shipping for service.

If the device was purchased from a business partner, contact that business partner for support.

Chapter 1

Getting Started

This chapter provides information for getting the device up and running for the first time.

Unpacking

Procedure:

- 1 Carefully remove all protective material from the TC75 and save the shipping container for later storage and shipping.
- 2 Verify that the following were received:
 - TC75 mobile computer
 - 4,620 mAh Lithium-ion battery
 - Hand strap
 - Regulatory Guide
 - Quick Start Guide.
- 3 Inspect the equipment for damage. If any equipment is missing or damaged, contact the Global Customer Support center immediately.
- 4 Prior to using the TC75 for the first time, remove the protective shipping film that covers the scan window, display and camera window.

Features

Figure 2: TC75 Front View

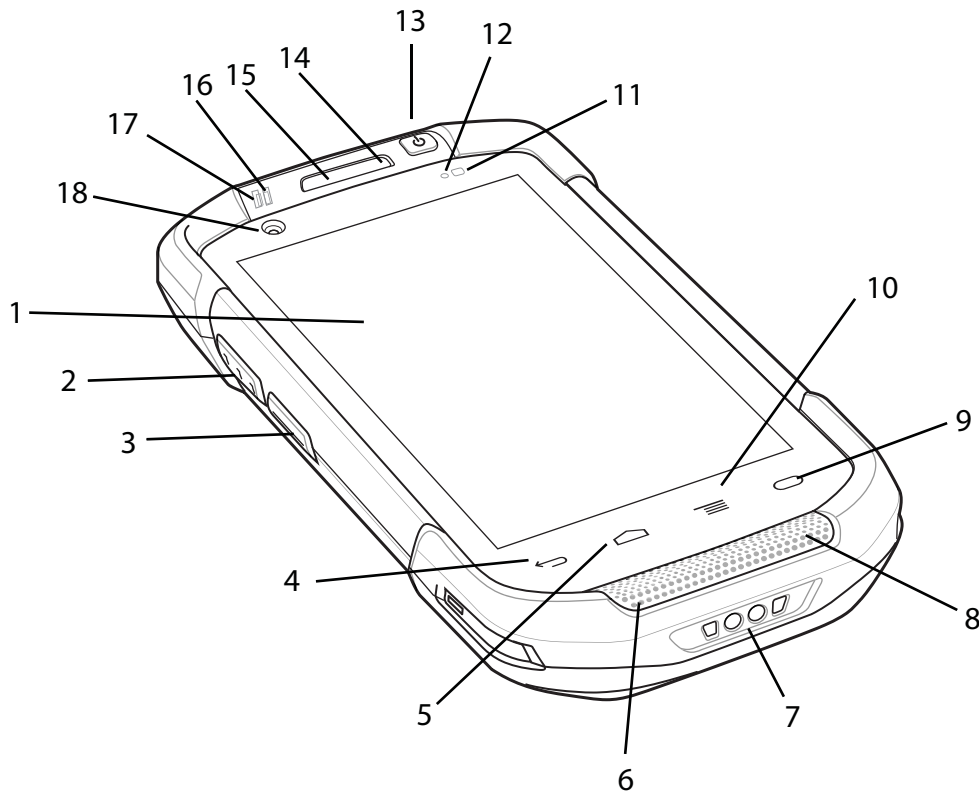

Table 1: Front View Features

Number	Item	Function
1	Touch Screen	Displays all information needed to operate the TC75.
2	Scan Button	Initiates data capture (programmable).
3	PTT Button	Initiates push-to-talk communications (programmable).
4	Back Button	Displays the previous screen.
5	Home Button	Displays the Home screen with a single press. Displays recently used applications when held for a short period of time. On TC75 with GMS, opens the Google Now screen when held for a short period of time.
6	Microphone	Use for communications in Handset mode.
7	Charging Contacts	Provides power to the device from cables and cradles.
8	Speaker	Provides audio output for video and music playback. Provides audio in speakerphone mode.

Table continued...

Number	Item	Function
9	Search Button	Opens the search application (programmable). On TC75 with GMS, opens the Recent App screen.
10	Menu Button	Opens a menu with items that affect the current screen or application.
11	Light Sensor	Determines ambient light for controlling display backlight intensity.
12	Proximity Sensor	Determines proximity for turning off display when in handset mode.
13	Power Button	Turns the display on and off. Press and hold to reset the device or power off.
14	Microphone	Use for communications in Speakerphone mode.
15	Receiver	Use for audio playback in Handset mode.
16	Charging/Notification LED	Indicates battery charging status while charging and application generated notifications..
17	Data Capture LED	Indicates data capture status.
18	Front Facing Camera	Use to take photos and videos.

Figure 3: TC75 Rear View

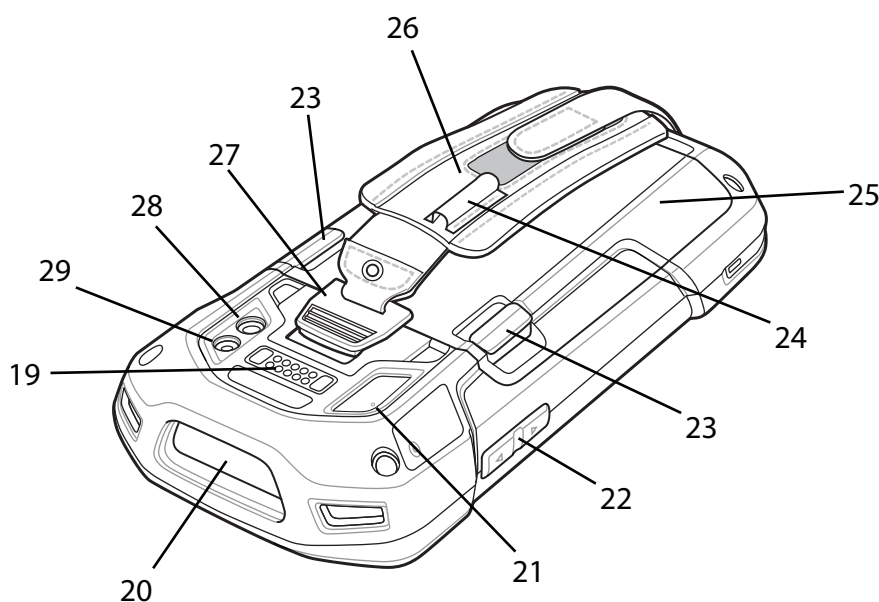

Table 2: Back View Features

Number	Item	Function
19	Interface Connector	Provides USB host and client communications, audio and device charging via cables and accessories.
20	Exit Window	Provides data capture using the imager.
21	Microphone	Use during video recording and for noise cancellation.

Table continued...

Number	Item	Function
22	Volume Up/Down Button	Increase and decrease audio volume (programmable).
23	Battery Release Latches	Press to remove the battery.
24	Elastic Sleeve	Use to hold optional stylus.
25	Battery	Provides power to the device.
26	Hand strap	Use to securely hold the device in your hand.
27	Hand strap Mounting Point	Provides latching point for the hand strap.
28	Camera	Takes photos and videos.
29	Camera Flash	Provides illumination for the camera.

Setup

When and where to use: Perform this procedure to start using the TC75 for the first time.

Procedure:

- 1 Install a SIM card.
- 2 Install a micro secure digital (SD) card (optional).
- 3 Install hand strap (optional).
- 4 Install the battery.
- 5 Charge the TC75.
- 6 Power on the TC75.

Installing the SIM Card



Caution:

For proper electrostatic discharge (ESD) precautions to avoid damaging the SIM card. Proper ESD precautions include, but not limited to, working on an ESD mat and ensuring that the user is properly grounded.



Note:

The TC75 may contain one mini SIM slot and two nano SIM slots. If using a micro SIM card, a third-party SIM adapter is required. By default, use a nano SIM card in slot 1.

Procedure:

- 1 Remove access cover.

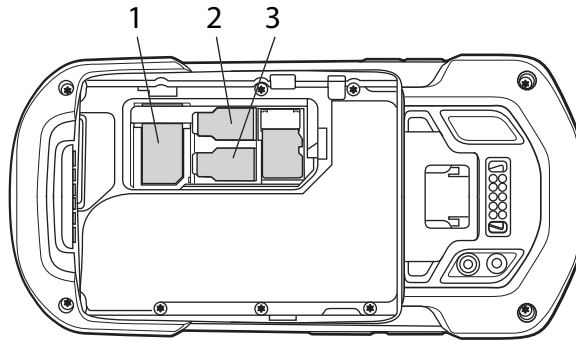
Figure 4: SIM Slot Locations

1	mini SIM/SAM Slot
2	nano SIM Slot 1 (default)
3	nano SIM Slot 2

- 2 Insert a SIM card into the SIM slot with the cut edge toward the middle of the device and the contacts facing down.

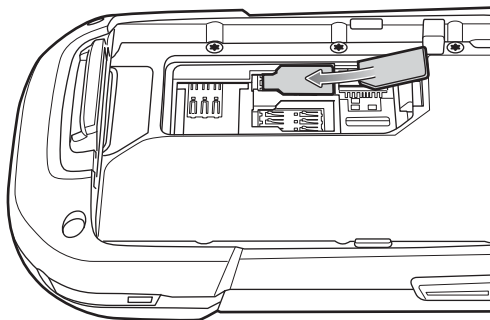
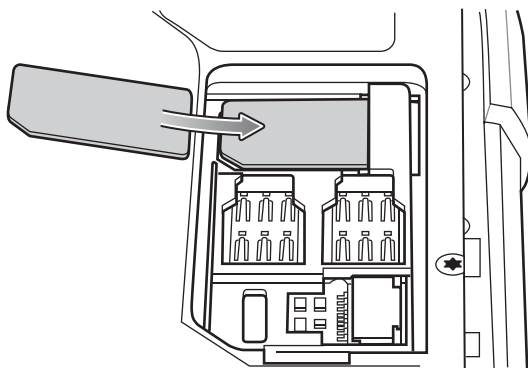
Figure 5: nano SIM Card Installation**Figure 6: Mini SIM Card Installation**

- 3 Ensure that the SIM card is seated properly.

Installing the SAM Card



Caution:

For proper electrostatic discharge (ESD) precautions to avoid damaging the Secure Access Module (SAM) card. Proper ESD precautions include, but not limited to, working on an ESD mat and ensuring that the user is properly grounded.

**Note:**

The TC75 contains one slot for a mini SAM card. If using a micro SAM card, a third-party adapter is required. When using a SAM card, only a nano SIM card can be used.

Procedure:

- 1 Remove access cover.
- 2 Insert a SAM card into the SAM slot with the cut edge toward the middle of the device and the contacts facing down.

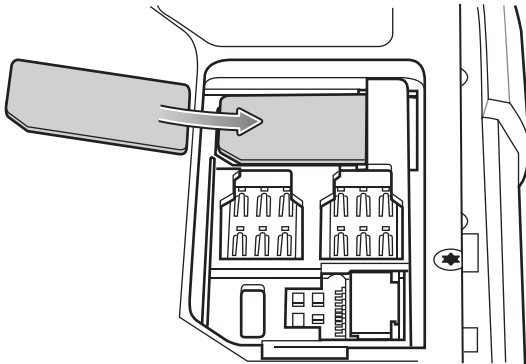
Figure 7: SAM Card Installation

- 3 Ensure that the SAM card is seated properly.

Installing a microSD Card

The microSD card slot provides secondary non-volatile storage. The slot is located under the battery pack. Refer to the documentation provided with the card for more information, and follow the manufacturer's recommendations for use.



Caution: Follow proper electrostatic discharge (ESD) precautions to avoid damaging the microSD card. Proper ESD precautions include, but are not limited to, working on an ESD mat and ensuring that the operator is properly grounded.

Procedure:

- 1 Remove the hand strap, if installed.
- 2 Lift the access door.

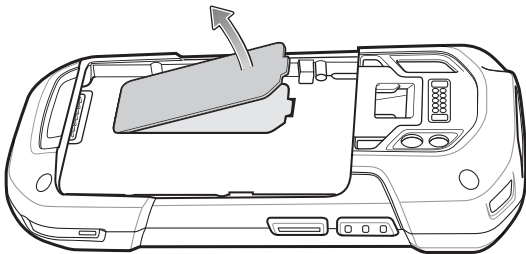
Figure 8: Lift Access Door

- 3 Insert the microSD card into the card holder door ensuring that the card slides into the holding tabs on each side of the door.

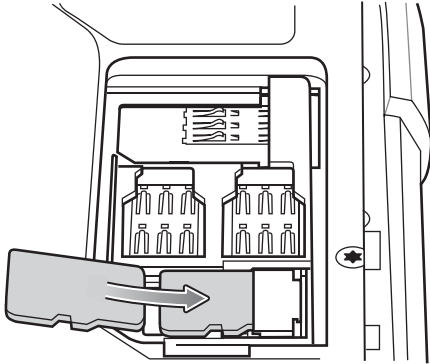
Figure 9: Insert microSD Card in Holder

- 4 Re-install the access door.

Installing the Hand Strap and Battery



Note: Installation of the hand strap is optional. Skip this section if not installing the hand strap.

Procedure:

- 1 Remove the hand strap filler from the hand strap slot. Store the hand strap filler in a safe place for future replacement.

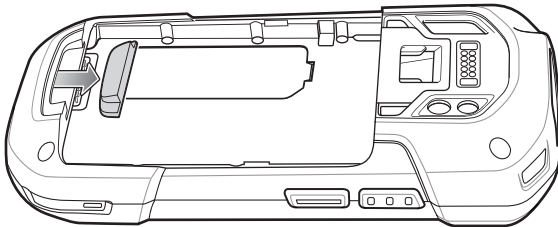
Figure 10: Remove Filler

- 2 Insert the hand strap plate into the hand strap slot.

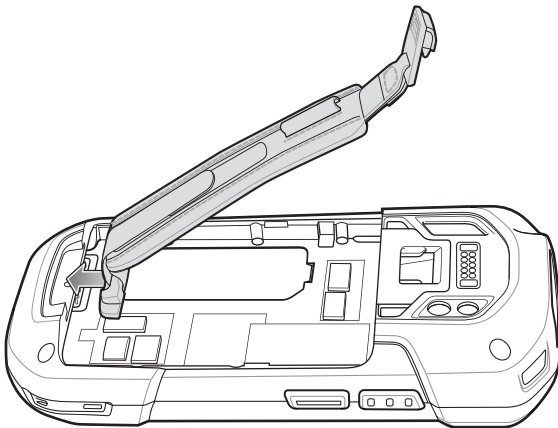
Figure 11: Insert Hand Strap

- 3 Insert the battery, bottom first, into the battery compartment in the back of the TC75.

Figure 12: Insert Bottom of Battery into Battery Compartment

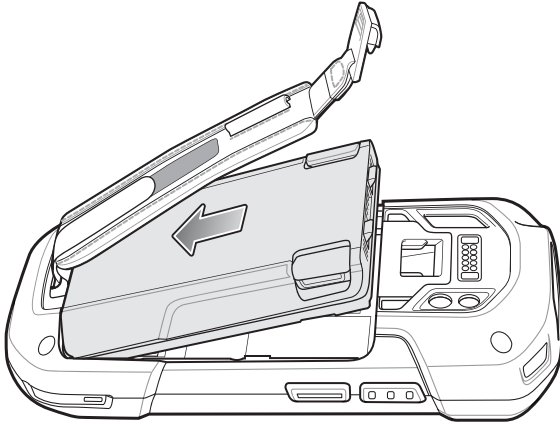

- 4 Rotate the top of the battery into the battery compartment.
- 5 Press the battery down into the battery compartment until the battery release latches snap into place.

Figure 13: Press Down on Battery

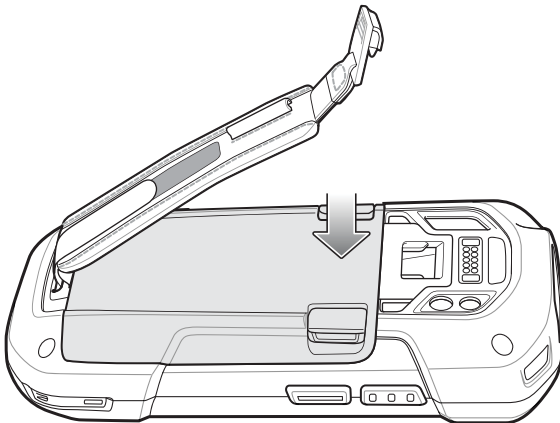

- 6 Place hand strap clip into hand strap mounting slot and pull down until it snaps into place.

Figure 14: Secure Hand Strap Clip

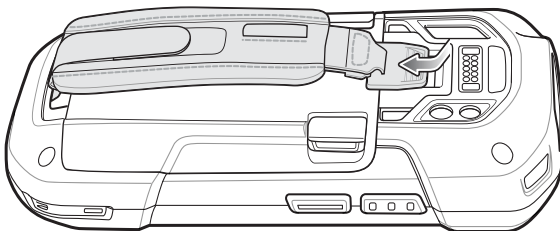

Installing the Battery

Procedure:

- 1 Insert the battery, bottom first, into the battery compartment in the back of the TC75.

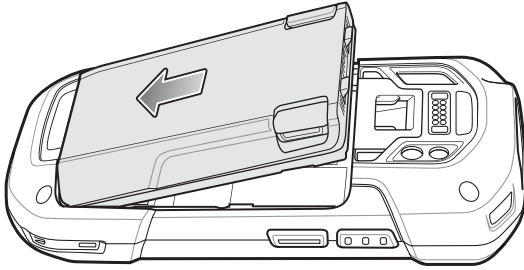
Figure 15: Insert Bottom of Battery into Battery Compartment

- 2 Rotate the top of the battery into the battery compartment.
- 3 Press the battery down into the battery compartment until the battery release latches snap into place.

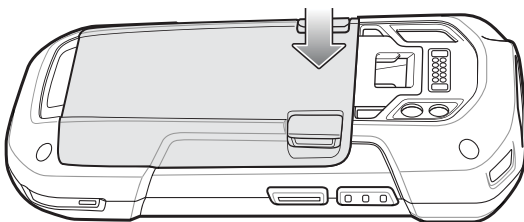
Figure 16: Press Down on Battery

Charging the Battery

Before using the TC75 for the first time, charge the main battery until the green Charging/Notification light emitting diode (LED) remains lit. To charge the TC75, use a cable or a cradle with the appropriate power supply. For information about the accessories available for the TC75, see [Accessories on page 139](#) for more information.

- Snap-On USB Cable
- Charging Cable Cup
- 2-Slot Charge Only Cradle
- 2-Slot USB/Ethernet Cradle
- 5-Slot Charge Only Cradle
- 5-Slot Ethernet Cradle
- Charge Only Vehicle Cradle
- Auto Charging Cable Cup.
- Serial Cable Cup

The 4,620 mAh battery fully charges in approximately six hours at room temperature.

Charge batteries in temperatures from 0 °C to 40 °C (32 °F to 104 °F). The TC75 or accessory always performs battery charging in a safe and intelligent manner. At higher temperatures (e.g. approximately +37 °C (+98 °F)) the TC75 or accessory may for small periods of time alternately enable and disable battery charging to keep the battery at acceptable temperatures. The TC75 or accessory indicates when charging is disabled due to abnormal temperatures via its LED.

Procedure:

- 1 To charge the main battery, connect the charging accessory to the appropriate power source.
- 2 Insert the TC75 into a cradle or attach to a cable. The TC75 turns on and begins charging. The Charging/Notification LED blinks amber while charging, then turns solid green when fully charged.

Charging Indicators

Table 3: Charging/Notification LED Charging Indicators

State	Indication
Off	TC75 is not charging. TC75 is not inserted correctly in the cradle or connected to a power source. Charger/cradle is not powered.
Slow Blinking Amber (1 blink every 2 seconds)	TC75 is charging.
Solid Green	Charging complete.
Fast Blinking Amber (2 blinks/second)	Charging error, e.g.: <ul style="list-style-type: none"> • Temperature is too low or too high. • Charging has gone on too long without completion (typically eight hours).
Slow Blinking Red (1 blink every 2 seconds)	TC75 is charging but the battery is at end of useful life.
Solid Red	Charging complete but the battery is at end of useful life.
Fast Blinking Red (2 blinks/second)	Charging error but the battery is at end of useful life., e.g.: <ul style="list-style-type: none"> • Temperature is too low or too high. • Charging has gone on too long without completion (typically eight hours).

Google Account Setup



Note:

The TC75 has to be connected to the internet, either through WAN or Wi-Fi, in-order to set up a Google account.

The first time the TC75 starts, the Setup Wizard displays. Follow the on-screen instructions to set up a Google account, configure Google Wallet for purchasing items from the Play Store, entering your personal information, and enabling backup/restore features.

Replacing the Battery



Caution: Do not add or remove SIM, SAM or microSD card during battery replacement.

Procedure:

- 1 Remove any accessory attached to the device.
- 2 Press the Power button until the menu appears.
- 3 Touch **Battery Swap**.
- 4 Follow the on-screen instructions.
- 5 Wait for the LED to turn off.
- 6 If hand strap is attached, slide the hand strap clip up toward the top of the TC75 and then lift.

Figure 17: Remove Hand Strap Clip

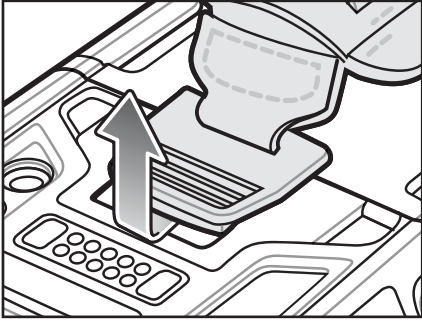

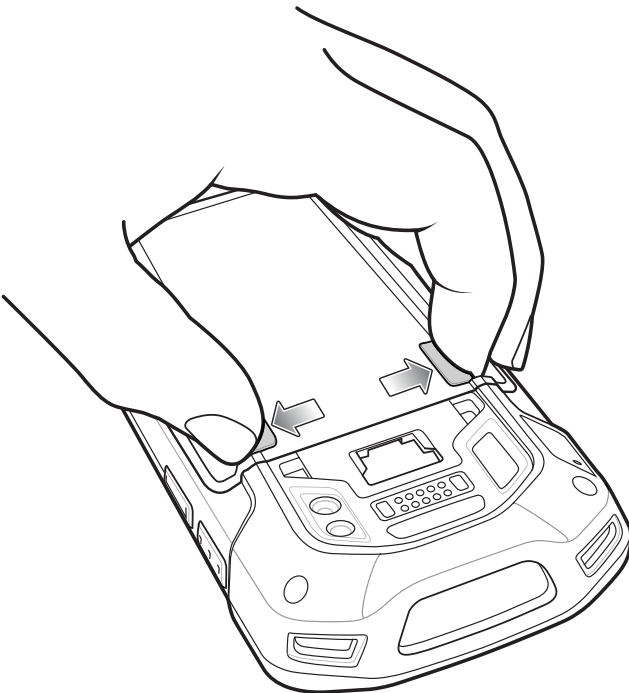

- 7 Press the two battery latches in.

Figure 18: Press Battery Latches

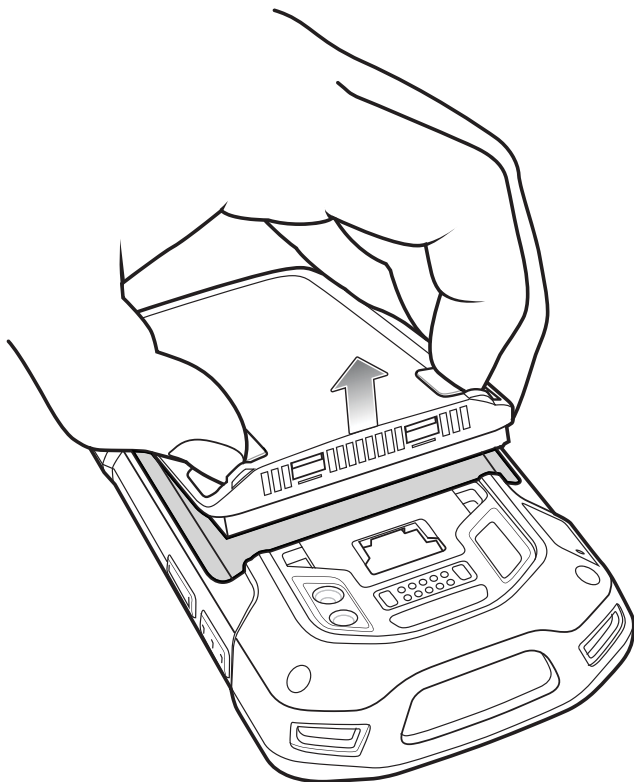

- 8 Lift the battery from the TC75.

Figure 19: Lift the Battery

- 9  **Caution:** Replace the battery within two minutes. After two minutes the device reboots and data may be lost.

Insert the replacement battery, bottom first, into the battery compartment in the back of the TC75.

- 10 Press the battery down until the battery release latch snaps into place.
 11 Replace the hand strap, if required.
 12 Press and hold the Power button to turn on the TC75.

Replacing the SIM or SAM Card

Procedure:

- 1 Press and hold the Power button until the menu appears.
- 2 Touch **Power off**.
- 3 Touch **OK**.
- 4 If hand strap is attached, slide the hand strap clip up toward the top of the TC75 and then lift.

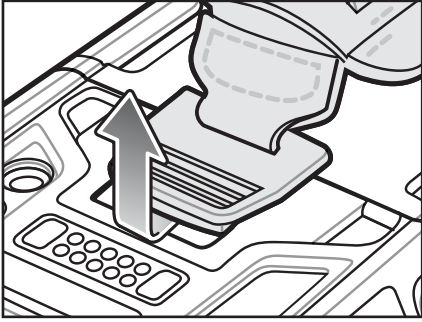
Figure 20: Remove Hand Strap Clip

- 5 Press the two battery latches in.
- 6 Lift the battery from the TC75.
- 7 Lift the access door.

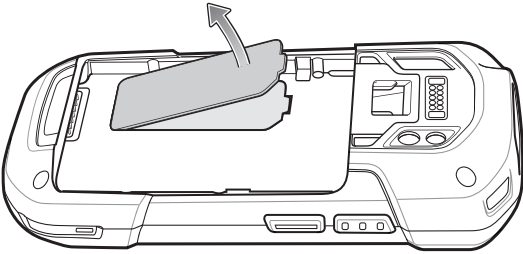
Figure 21: Remove Access Door

- 8 Remove card from holder.

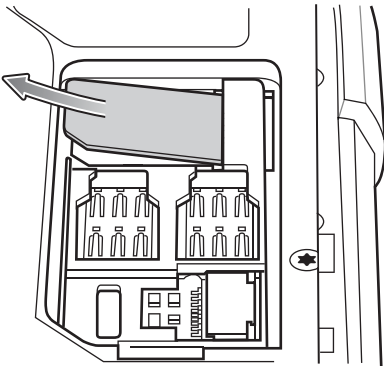
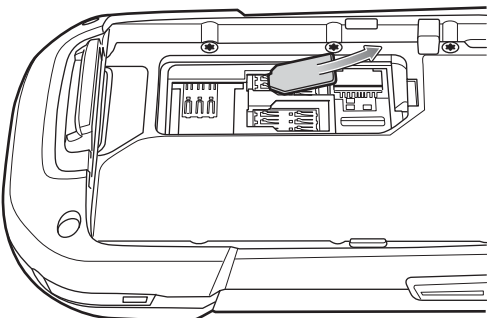
Figure 22: Remove Mini SIM/SAM Card**Figure 23: Remove Nano SIM Card**

- 9 Insert the replacement card.

Figure 24: Insert Mini SIM/SAM Card

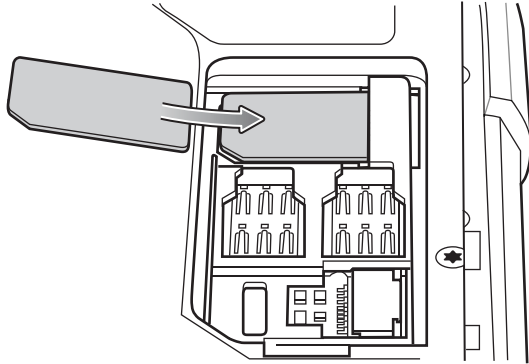
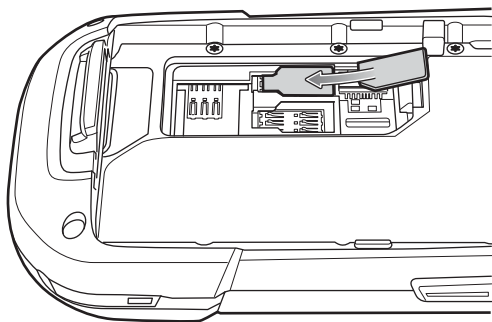
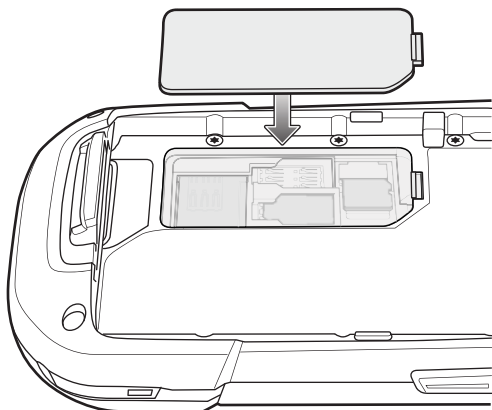

Figure 25: Insert Nano SIM Card



10 Replace the access door.

Figure 26: Replace Access Door



- 11** Press the access door down and ensure that it is properly seated.
- 12** Insert the battery, bottom first, into the battery compartment in the back of the TC75.
- 13** Press the battery down until the battery release latch snaps into place.
- 14** Replace the hand strap, if required.
- 15** Press and hold the Power button to turn on the TC75.

Replacing the microSD Card

Procedure:

- 1 Press the Power button until the menu appears.
- 2 Touch **Power off**.
- 3 Touch **OK**.
- 4 If hand strap is attached, slide the hand strap clip up toward the top of the TC75 and then lift.

Figure 27: Remove Hand Strap Clip

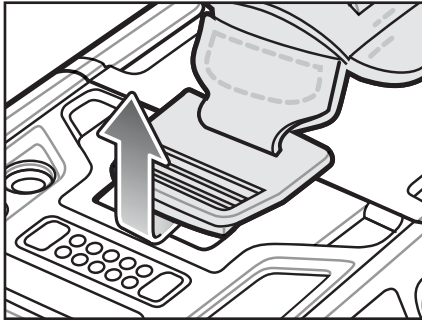

- 5 Press the two battery latches in.
- 6 Lift the battery from the TC75.
- 7 Lift the access door.

Figure 28: Remove Access Door

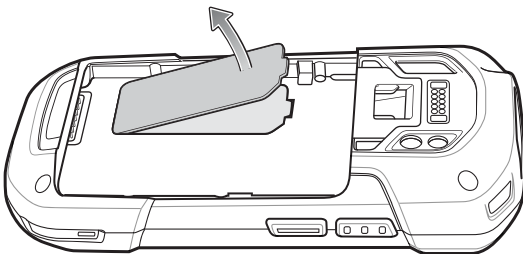

- 8 Remove microSD card from holder.
- 9 Press the access door down and ensure that it is properly seated.
- 10 Insert the replacement microSD card.
- 11 Replace the access door.

Figure 29: Replace Access Door

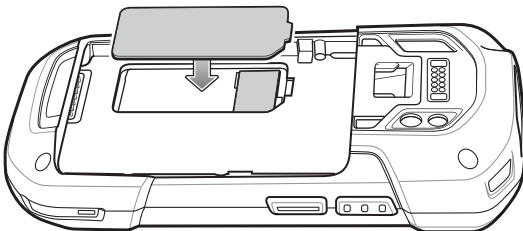

- 12 Insert the battery, bottom first, into the battery compartment in the back of the TC75.
- 13 Press the battery down until the battery release latch snaps into place.
- 14 Replace the hand strap, if required.



15 Press and hold the Power button to turn on the TC75.

Battery Management



Note:

Prior to checking the battery charge level, remove the TC75 from any AC power source (cradle or cable).

To check the charge status of the main battery, on the Home screen touch  >  >  **About phone** > **Battery Management**.

Battery status indicates that the battery is discharging and **Battery level** lists the battery charge (as a percentage of fully charged).

Monitor Battery Usage

The **Battery** screen lists which applications consume the most battery power. Also use it to turn off applications that were downloaded if they are consuming too much power.

Touch  >  > **Battery**.

Figure 30: Battery Screen

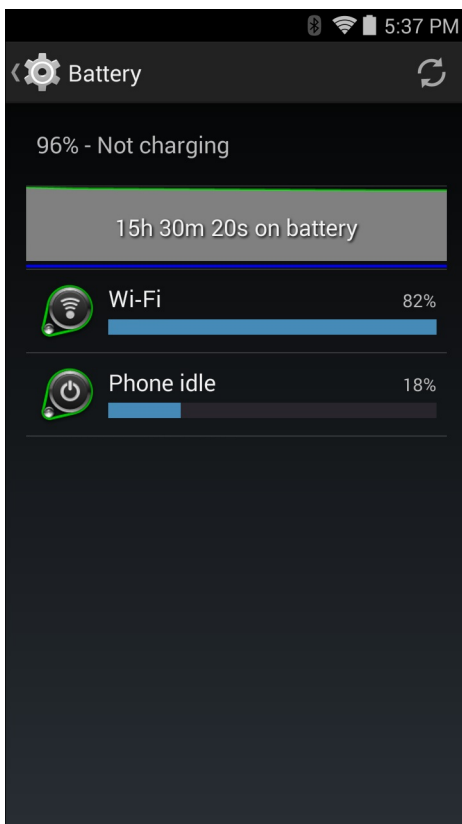

The **Battery** screen lists the applications using the battery. The discharge graph at the top of the screen shows the rate of the battery discharge since last charged (short periods of time when connected to a charger are shown as thin green lines at the bottom of the chart), and how long it has been running on battery power.

Touch an application in the **Battery** screen to display details about its power consumption. Different applications display different information. Some applications include buttons that open screens with settings to adjust power use.

Low Battery Notification

When the battery charge level drops below 18%, the TC75 displays a notice to connect the TC75 to power. The user should charge the battery using one of the charging accessories.

Figure 31: Low Battery Notification

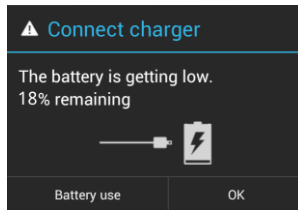

When the battery charge drops below 10%, the TC75 displays a notice to connect the TC75 to power. The user must charge the battery using one of the charging accessories.

When the battery charge drops below 4%, the TC75 turns off.

The user must charge the TC75 using one of the charging accessories.

Battery Optimization

Observe the following battery saving tips:

- Disable DataWedge Launcher profile. See *TC75 Integrator Guide* for instructions.
- Remove Snap-on accessories when not in use.
- Set the screen to turn off after a short period of non-use. See [Setting Screen Timeout Setting on page 35](#).
- Reduce screen brightness. See [Setting the Screen Brightness on page 34](#).
- Turn off all wireless radios when not in use.
- Turn off automatic syncing for Email, Calendar, Contacts and other applications.
- Use the **Power Control** widget to check and control the status of radios, the screen brightness, and syncing.
- Minimize use of applications that keep the TC75 from suspending, for example, music and video applications.

Turning Off the Radios



Procedure:

- 1 Press the Power button until the menu appears.
- 2 Touch **Airplane mode**. The airplane icon  appears in the Status bar indicating that all the radios are off.

Setting the Date and Time

The date and time is automatically synchronized using a NITZ server when the TC75 is connected to a cellular network. The user is only required to set the time zone or set the date and time when not connected to a cellular network or if the wireless LAN does not support Network Time Protocol (NTP).

Procedure:

- 1 On the Home screen, touch .
- 2 Touch .
- 3 Touch  **Date & time**.
- 4 Touch **Automatic date & time** to disable automatic date and time synchronization.

- 5 Touch **Set date**.
- 6 Move the sliders up and down to select the month, date and year.
- 7 Touch **Done**.
- 8 Touch **Set time**.
- 9 Move the sliders up and down to select the hour, minutes and part of the day.
- 10 Touch **Done**.
- 11 Touch **Select time zone**.
- 12 Select the current time zone from the list.
- 13 Touch .

Display Setting

Use Display settings to change the screen brightness, change the background image, enable screen rotation, set sleep time and change font size.

Setting the Screen Brightness

To set the screen brightness:

Procedure:

- 1 Touch .
- 2 Touch .
- 3 Touch  **Display**.
- 4 Touch **Brightness**.

Figure 32: Brightness Dialog Box





- 5 In the **Brightness** dialog box, touch **Auto** to set the TC75 to automatically adjust the brightness using the built-in light sensor. Deselect **Auto** to set the brightness manually. Use the slider to set a brightness level.
- 6 Touch .

Setting Screen Rotation

By default, screen rotation is disabled. To enable screen rotation:

Procedure:

- 1 On the Home screen, touch .
- 2 Touch .
- 3 Touch  **Display**.
- 4 Check **Auto-rotate screen** to set the TC75 to automatically switch orientation when the TC75 is rotated.



Note:





The Home screen does not rotate.

- 5 Touch .

Setting Screen Timeout Setting

To set the screen sleep time:





Procedure:

- 1 On the Home screen, touch .
- 2 Touch .
- 3 Touch  **Display**.
- 4 Touch **Sleep**.
- 5 Select one of the sleep values.
 - **15 seconds**
 - **30 seconds**
 - **1 minute** (default)
 - **2 minutes**
 - **5 minutes**
 - **10 minutes**
 - **30 minutes**
- 6 Touch .

Setting Font Size

To set the size of the font in system applications:



Procedure:

- 1 Touch .
- 2 Touch .
- 3 Touch  **Display**.
- 4 Touch **Font size**.
- 5 Select one of the font size values.
 - **Small**
 - **Normal** (default)
 - **Large**
 - **Huge**
- 6 Touch .

Setting Touch Key Light

The four touch keys under the screen are backlit. Configure the touch key light to save battery power.

Procedure:

- 1 Touch .
- 2 Touch .
- 3 Touch  **Display**.
- 4 Touch **Touch key light**.
- 5 Select one of the options.
 - **Always off** - The touch key light is off.

- **6 seconds** - The touch key light stays on for six seconds and then turns off (default).
- **10 seconds** - The touch key light stays on for 10 seconds and then turns off.
- **15 seconds** - The touch key light stays on for 15 seconds and then turns off.
- **30 seconds** - The touch key light stays on for 30 seconds and then turns off.
- **1 minute** - The touch key light stays on for one minute and then turns off.
- **Always on** - The touch key light is on when the screen is on.

Figure 33: Touch Key Light Dialog Box

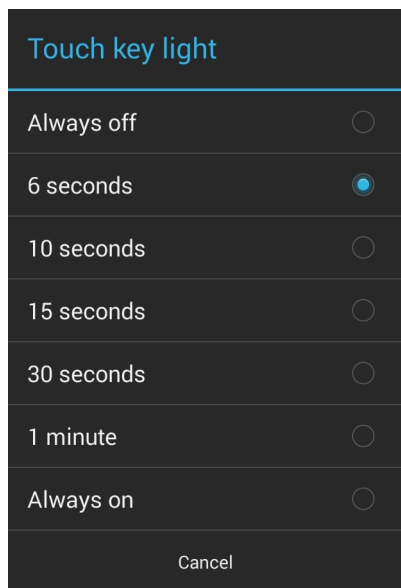

6 Touch .

Touch Mode

The TC75 display is able to detect touches using a finger, a conductive-tip stylus or gloved finger.



Note:

A glove can be made of medical latex, leather, cotton or wool.

For optimal performance use Zebra certified stylus.

Procedure:





- 1 Touch .
- 2 Touch .
- 3 Touch  **Display**.
- 4 Touch **Touch Mode**.

Figure 34: Touch Mode Dialog Box





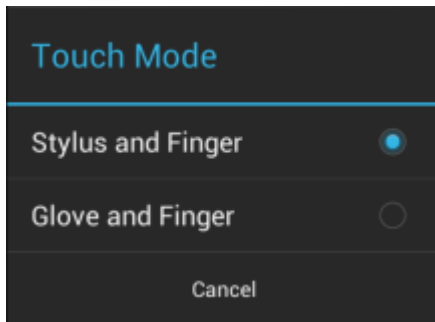

- 5 Touch **Stylus and Finger** to use a finger or a stylus on the screen or touch **Glove and Finger** to use a finger or a gloved finger on the screen.
- 6 Touch .



Setting Notification LED

The Charging/Notification LED lights blue when an application, such as email and VoIP, generates a programmable notification or to indicate when the TC75 is connected to a Bluetooth device. By default, LED notifications are enabled. To change the notification setting:

Procedure:

- 1 On the Home screen, touch .
- 2 Touch .
- 3 Touch  **Display**.
- 4 Touch **Pulse notification light** to toggle the notification on or off.
- 5 Touch .

General Sound Setting

Use the **Sounds** settings to configure media and alarm volumes. On the Home screen, touch  >  >  **Sounds**.



Alternately, touch the Status bar and drag down to open the Notification panel. Touch  >  >  **Sounds**.

Figure 35: Sounds Screen



- **Volumes** – Use to change the volume of media, ringtones, notifications and alarms.

Figure 36: Volumes Dialog Box

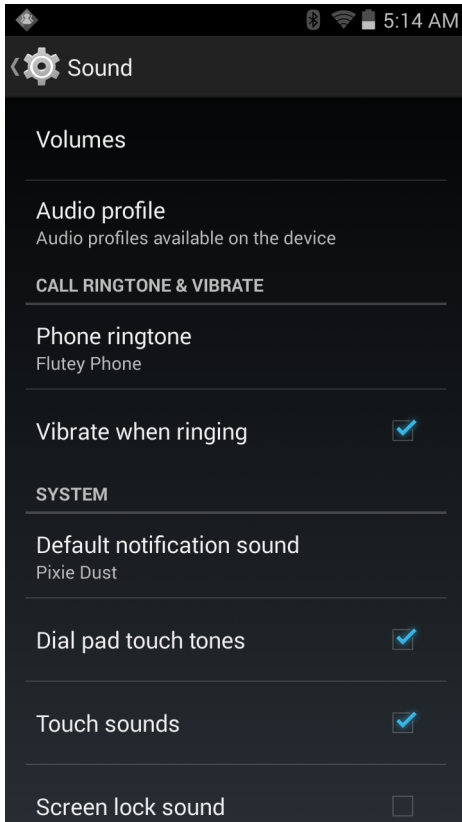
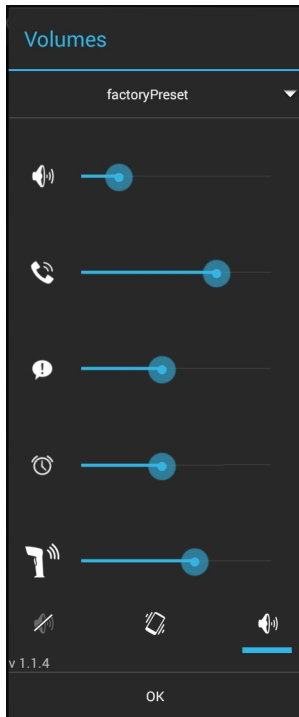









-  - Controls the music and media volume.
-  - Controls the ringtone volume.
-  - Controls the system notification volume.
-  - Controls the alarm clock volume.
-  - Controls the scan good decode beep volume.
- Bottom row icons:
 - +  - Places all sounds except media and alarms in silence mode.
 - +  - Places all sounds except media and alarms in vibrate mode.
 - +  - Places all sounds in sound mode.
- **Audio profile** – Touch to set audio profile. On the **Audio profile** screen, touch **Audio profile**.

Figure 37: Audio Profile Dialog Box



- **General** – Standard audio settings (default).
- **increased clarity** – Increased volume on higher frequencies.
- **Call Ringtone and Vibrate**
 - **Phone ringtone** - Touch to select a ringtone to sound when an incoming call is received.
 - **Vibrate when ringing** - Check to make the device vibrate when a call is received (default – enabled).
- **System**
 - **Default notification** - Touch to select a sound to play for all system notifications.
 - **Dial pad touch tones** - Check to play a sound when a phone key is touched (default – enabled).
 - **Touch sounds** - Check to play a sound when making screen selections (default – enabled).
 - **Screen lock sounds** - Check to play a sound when locking and unlocking the screen (default – disabled).

- **Vibrate on touch** - Check to have the device vibrate when touching soft keys and on certain screen interactions (default – enabled).

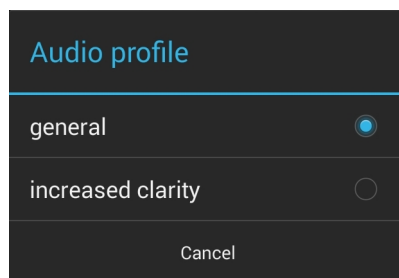
Wake-Up Sources

By default the TC75 wakes from suspend mode when the user presses the power button. The TC75 can be configured to wake when the user presses the PPT or Scan buttons on the left side of the device.

Procedure:





- 1 Touch .
- 2 Touch .
- 3 Touch  **Wake-Up Sources**.
- 4 Touch **Keypad** checkbox. A blue check appears in the checkbox.

Figure 38: Wake-Up Sources Dialog Box

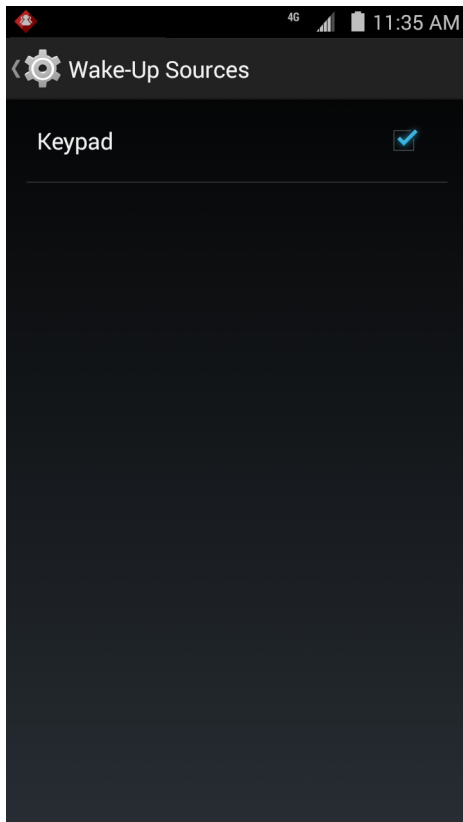

- 5 Touch .

Chapter 2

Using the TC75

Introduction

This chapter explains the buttons, status icons, and controls on the TC75, and provides basic instructions for using the TC75, including resetting the TC75 and entering data.

Google Mobile Services



Note: This section only applies to TC75 configurations with Google Mobile Services (GMS).

The TC75 with GMS contains applications and services that provide additional functionality to the TC75.

GMS includes:

- **Applications** - GMS adds a variety of Google applications and associated widgets including Chrome, Gmail, Drive and Maps.
- **Services:**
 - **Speech to Text** - Allows for free format speech to text, in many languages for both connected and disconnected network. Launch by touching the microphone icon on the keyboard.
 - **TalkBack Service** - Provides spoken feedback on various parts of the user interface. To enable, go to **Settings > Accessibility**.
 - **Network Location Provider** - Adds a location provider which uses mobile network tower information and Wi-Fi access point information to provide a location without using GPS. To enable, go to **Settings > Location access**.
 - **Widevine DRM** - Enables the digital rights management so that protected content can be played. Enable via DRM Info from the Play Store.
 - **Google Cloud Messaging** - Allows the sending of data from your server to your TC75 and also to receive messages from devices on the same connection.
 - **Backup and Restore** - Allows the users settings and applications to be backed up to a Google server and subsequently restored from that server after a factory reset.
- **Google accounts** - Create and use a Google account to synchronize mail, files, music, photos, contacts and calendar events.

Home Screen

The Home screen displays when the TC75 turns on. Depending upon the configuration, the Home screen might appear different. Contact your system administrator for more information.



After a suspend or screen time-out, the Home screen displays with the lock sliders. Slide  to the right toward  to unlock the screen. For screen locking information see [Un-Locking the Screen on page 55](#).

Figure 39: Home Screen



Table 4: Home Screen Items

Item	Description
1 — Status Bar	Displays the time, status icons (right side), and notification icons (left side). For more information see Status Icons on page 43 and Managing Notifications on page 45 .
2 — Browser Icons	Opens browser application.
3 — All Apps Icon	Opens the APPS window.
4 — Shortcut Icons	Opens applications installed on the TC75. See Application Shortcuts and Widgets on page 47 for more information.
5 — Widgets	Launches stand-alone applications that run on the Home screen. See Application Shortcuts and Widgets on page 47 for more information.

The Home screen provides four additional screens for placement of widgets and shortcuts. Swipe the screen left or right to view the additional screens.

Status Bar

The Status bar displays the time, notification icons (left side) and status icons (right side).

Figure 40: Notification and Status Icons



Table 5: Home Screen Items

Item	Description
1	Notification icons.
2	Status icons.

If there are more notifications than can fit in the Status bar,  displays indicating that more notifications exist. Open the Notifications panel to view all notifications and status.

Status Icons

Table 6: Status Icons























Icon	Description
	Indicates that the Alarm is active.
	Indicates that all sounds except media and alarms are silenced and vibrate mode is active.
	Indicates that all sounds except media and alarms are silenced.
	Indicates that the battery is fully charged.
	Indicates that the battery is partially drained.
	Indicates that the battery charge is low.
	Indicates that the battery charge is very low.
	Indicates that the battery is charging.
	Indicates that the Airplane Mode is active. All radios are turned off.
	Indicates that Bluetooth is on.

Table continued...

Icon	Description
	Indicates that the TC75 is connected to a Bluetooth device.
	Connected to a Wi-Fi network.
	No Wi-Fi signal.
	Mobile network signal strength.
	No mobile network signal.
	Connected to an 4G LTE network.
	Connected to an 4G network.
	Connected to a 3G network.
	Connected to an HSPA network.
	Connected to an EDGE network.
	Connected to an GPRS network.
	Roaming from a network.
	No SIM card installed.

Notification Icons

Table 7: Notification Icons

















Icon	Description
	Indicates that more notifications are available for viewing.
	Indicates that data is syncing.
	Indicates an upcoming event.

Table continued...

Icon	Description
	Indicates that an open Wi-Fi network is available.
	Indicates that a song is playing.
	Indicates that a problem with sign-in or sync has occurred.
	Indicates that the TC75 is uploading data.
	Indicates that the TC75 is downloading data when animated and download is complete when static.
	Indicates that the TC75 is connected via USB cable.
	Indicates that the TC75 is connected to or disconnected from virtual private network (VPN).
	Preparing SD card.
	Indicates that USB debugging is enabled on the TC75.
	Indicates that the MultiUser feature is enabled. Appears only when MultiUser Administrator application is installed.
	Indicates that a new user is logging in. Appears only when MultiUser Administrator application is installed.
	Indicates the status of the PTT Express Voice Client. See Notification Icons on page 95 for complete list of PTT Express notification icons.
	Indicates that DataWedge application is running on the device.

Managing Notifications

Notification icons report the arrival of new messages, calendar events, and alarms, as well as ongoing events. When a notification occurs, an icon appears in the Status bar with a brief description. See [Notification Icons on page 44](#) for a list of possible notification icons and their description. Open the **Notifications** panel to view a list of all the notifications.

To open the Notification panel drag the Status bar down from the top of the screen.

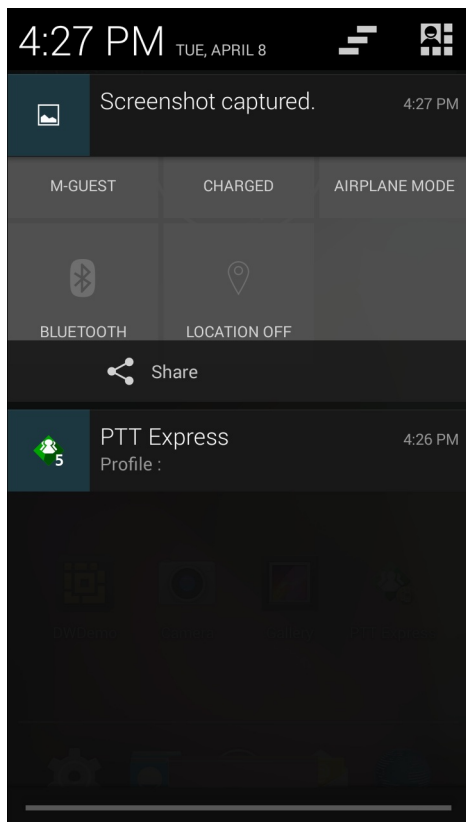
Figure 41: Notification Panel

To respond to a notification, open the Notifications Panel and then touch a notification. The Notifications Panel closes and the subsequent activity is dependent on the notification.

To clear all notifications, open the Notifications Panel and then touch . All event-based notifications are removed. Ongoing notifications remain in the list.

Touch  to open the Quick Settings screen.

To close the Notification Panel, drag the bottom of the Notifications Panel to the top of the screen or touch .

Quick Settings

The Quick Settings panel provides easy access to some frequently used settings.



Drag the Status bar down from the top of the screen. The Quick Settings icon displays in the top right corner. Touch  to display the **Quick Settings** panel.

Figure 42: Quick Settings

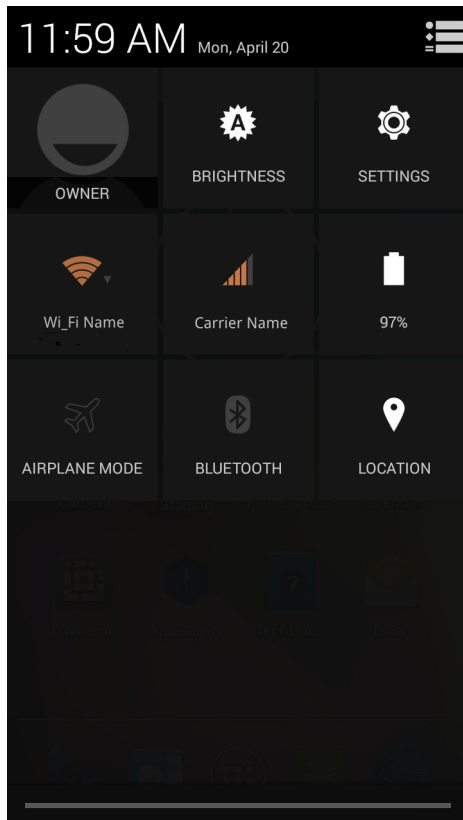

- **Owner** – Display the owner’s contact image. Touch to open the owner’s contact information. User must first set up contact information in **People** application.
- **Brightness** – Opens the Brightness setting dialog box to set the screen brightness.
- **Settings** – Opens the **Settings** screen.
- **Wi-Fi** – Displays the current Wi-Fi connection. Touch to opens the **Wi-Fi** settings screen.
- **Carrier Name** – Displays the current carrier connection. Touch to opens the **Data Usage** settings screen.
- **Battery** – Displays the current battery charge level. Touch to opens the **Battery** screen.
- **Airplane Mode** – Displays the Airplane mode status. Touch to toggle Airplane mode on and off. Turn on Airplane mode to turn off all the radios.
- **Bluetooth** – Displays the current state of the Bluetooth radio. Touch to open the **Bluetooth** settings screen.
- **Location** – Displays the current state of the Location settings. Touch to opens the **Location** settings screen.

To close the Quick Settings Panel, drag the bottom of the Quick Settings Panel to the top of the screen, touch  at the top right corner of the screen or touch .

Application Shortcuts and Widgets

Application shortcuts placed on the Home screen allow quick and easy access to applications. Widgets are self-contained applications placed on the Home screen to access frequently used features.

Adding an Application or Widget to the Home Screen

Procedure:

- 1 Go to the desired Home screen.
- 2 Touch .

- 3 Swipe right, if necessary, to find the application icon or widget.
- 4 Touch and hold the icon or widget until the Home screen appears.
- 5 Position the icon on the screen and then release.

Moving Items on the Home Screen

Procedure:

- 1 Touch and hold the item until it floats on the screen.
- 2 Drag the item to a new location. Pause at the edge of the screen to drag the item onto an adjacent Home screen.
- 3 Lift finger to place the item on the Home screen.

Removing an App or Widget from the Home Screen

Procedure:

- 1 Go to the desired Home screen.
- 2 Touch and hold the application shortcut or widget icon until it floats on the screen.
- 3 Drag the icon to  **Remove** on the top of the screen and then release.

Folders

Use **Folders** to organize similar applications together. Tap the folder to open and display items in the folder.

Creating a Folder

To create a folder, there must be at least two app icons on the Home screen.

Procedure:

- 1 Go to the desired Home screen.
- 2 Touch and hold on one application icon.
- 3 Drag the icon and stack on top of another icon.
- 4 Lift and release.

Naming Folders

Procedure:

- 1 Touch the folder.

Figure 43: Open Folder

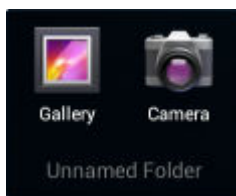

- 2 Touch the title area and enter a folder name using the keyboard.
- 3 Touch **Done** on the keyboard.
- 4 Touch anywhere on the Home screen to close the folder. The folder name appears under the folder.

Figure 44: Renamed Folder

Removing a Folder

Procedure:

- 1 Touch and hold the folder icon until it enlarges.
- 2 Drag the icon to  **Remove** and release.

Home Screen Wallpaper



Note: Use of Live Wallpaper may reduce battery life.

Changing the Home Screen Wallpaper

Procedure:

- 1 Touch .
- 2 Touch **Wallpaper**.
- 3 From the **Choose wallpaper from** menu, touch **Gallery**, **Live wallpapers** or **Wallpapers**.
 - **Gallery** - Select to use an image stored on the device.
 - **Live wallpapers** - Select to use an animated wallpaper image.
 - **Wallpapers** - Select to use a wallpaper image.
- 4 Touch **Save** or **Set wallpaper**.

Using the Touchscreen

Use the multi-tap sensitive screen to operate the device.

- **Tap** - Tap to:
 - select items on the screen
 - type letters and symbols using the on-screen keyboard
 - press on-screen buttons.
- **Tap and Hold** - Tap and hold:
 - an item on the Home screen to move it to a new location or to the trash.
 - an item in Apps to create a shortcut on the Home screen.
 - the Home screen to open a menu for customizing the Home screen.
 - an empty area on the Home screen until the menu appears.
- **Drag** - Tap and hold an item for a moment and then move finger on the screen until reaching the new position.
- **Swipe** - Move finger up and down or left and right on the screen to:
 - unlock the screen
 - view additional Home screens
 - view additional application icons in the Launcher window

- view more information on an application's screen.
- **Double-tap** - Tap twice on a web page, map, or other screen to zoom in and out.
- **Pinch** - In some applications, zoom in and out by placing two fingers on the screen and pinching them together (to zoom out) or spreading them apart (to zoom in).

Using the On-screen Keyboard

Use the on-screen keyboard to enter text in a text field. To configure the keyboard settings, touch and hold 



(comma) >  and then select **Android keyboard settings**.

Editing Text

Edit entered text and use menu commands to cut, copy, and paste text within or across applications. Some applications do not support editing some or all of the text they display; others may offer their own way to select text.

Entering Numbers, Symbols and Special Characters

To enter numbers and symbols:

- Touch and hold one of the top-row keys until a menu appears then select a number. Keys with alternate characters display an ellipsis (...) below the character.
- Touch and hold the Shift key with one finger, touch one or more capital letters or symbols to enter them, and then lift both fingers to return to the lowercase keyboard.
- Touch  to switch to the numbers and symbols keyboard.
- Touch the  key on the numbers and symbols keyboard to view additional symbols.

To enter special characters, touch and hold a number or symbol key to open a menu of additional symbols.

- A larger version of the key displays briefly over the keyboard.
- Keys with alternate characters display an ellipsis (...) below the character.

Applications

The **APPS** screen displays icons for all installed applications. The table below lists the applications installed on the TC75. Refer to the *TC75 Integrator Guide* for information on installing and uninstalling application.

Table 8: Applications



Icon	Description
	AppGallery - Provides links to utilities and demonstration applications that can be installed on the TC75.
	Battery Swap – Use to place device in Battery Swap mode when replacing the battery.

Table continued...











Icon	Description
	Bluetooth Pairing Utility – Use to pair the RS507 Hans-free Imager with the TC75 by scanning a bar code.
	Browser - Use to access the Internet or intranet. TC75 Professional (without GMS) only.
	Calculator - Provides the basic and scientific arithmetic functions.
	Calendar - Use to manage events and appointments.
	Camera - Take photos or record videos. For more information see Camera on page 76 .
	Chrome - Use to access the Internet or intranet. TC75 Standard (with GMS) only.
	Clock - Use to schedule alarms for appointments or as a wake-up.
	DataWedge - Enables data capture using the imager.
	Downloads - lists all downloads files.
	Drive - Upload photos, videos, documents, and other files to personal storage site. TC75 Professional (with GMS) only.
	DWDemo - Provides a way to demonstrate the data capture features using the imager. See DataWedge Demonstration on page 93 for more information.
 or 	elemz — Use to provide diagnostic information. See Elemz on page 105 for more information.
	Email - Use to send and receive email.
	File Browser - Organize and manage files on the TC75. See File Browser on page 73 for more information.

Table continued...

Icon	Description
	Gallery - Use to view photos stored on the microSD card. For more information, see Gallery on page 85 for more information.
	Gmail - Use to send and receive email using a Google email account. TC75 Standard (with GMS) only.
	Google - Launches Google search application. TC75 Standard (with GMS) only.
	Google Settings - Use to connect applications to Google account, setup Google Plus account, set location settings, set search features and configure Android Device Manager. TC75 Standard (with GMS) only.
	Google+ - Connect with people on Google social network. TC75 Standard (with GMS) only.
	Hangouts - Use to communicate with friends using text messages and photos. TC75 Standard (with GMS) only.
	Maps - Use to see you location on a map (with public transit, traffic or satellite overlays). Search for any business or place of interest. Provides turn-by-turn navigation with voice guidance and traffic-avoidance and alternate routes, for drivers, cyclist, walkers and users of public transportation. TC75 Standard (with GMS) only.
	Messaging - Send SMS and MMS messages. Messaging on page 74 for more information.
	MLog Manager - Use to capture log files for diagnostics. See MLog Manager on page 97 for more information.
	MobiControl Stage – Opens the MobiControl Stage application to stage the device.
	Movie Studio - Use to create movie videos.
	MSP Agent - Enables management of the TC75 from an MSP server. Requires the purchase of an appropriate MSP client license per device to suit the level of management functionality required.
	MSRN - Use verify authenticity of the paired Snap-on MSR and to provision the Snap-on MSR. See the <i>TC75 Integrator Guide</i> for more information.
	Music - Play music stored on the microSD card. TC75 Professional (without GMS) only.

Table continued...



























Icon	Description
	People - Use to manage contact information. <i>People on page 75</i> for more information.
	Phone - Use to dial a phone number when used with some Voice over IP (VoIP) clients (VoIP telephony ready only).
	Photos - Use to sync photos with Google account. TC75 Standard (with GMS) only.
	Play Books - Use to read books. TC75 Standard (with GMS) only.
	Play Games - Use to play games. TC75 Standard (with GMS) only.
	Play Magazines - Use to subscribe to magazine and read on-line. TC75 without GMS only.
	Play Movies & TV - View movies and video on your device. TC75 Standard (with GMS) only.
	Play Music - Use to listen to music. TC75 Standard (with GMS) only.
	Play Newsstand - Displays current news. TC75 Standard (with GMS) only.
	Play Store - Download music, movies, books, and Android apps and games from the Google Play Store. TC75 Standard (with GMS) only.
	PTT Express - Use to launch PTT Express client for VoIP communication.
	QLogcat - Use to collect and view system debug outputs.
	Rapid Deployment - Allows the TC75 to stage a device for initial use by initiating the deployment of settings, firmware and software. Requires the purchase of an MSP client license per device.
	RxLogger - Use to diagnose device and application issues. See the <i>TC75 Integrator Guide</i> for more information.

Table continued...

Icon	Description
	Search - Use the Google search engine to search the Internet and the TC75. TC75 Professional (without GMS) only.
	Settings - Use to configure the TC75.
	SimulScan Demo - Use to demonstrate the document capture feature of the TC75.
	Sound Recorder - Use to record audio. TC75 Professional (without GMS) only.
	StageNow - Allows the TC75 to stage a device for initial use by initiating the deployment of settings, firmware and software.
	TechDocs - Opens the on-device User Guide for the TC75.
	Voice Dialer - Use to place calls by speaking.
	Voice Search - Use to perform searches by asking questions. TC75 Standard (with GMS) only.
	YouTube - Use to view videos on the YouTube web site. TC75 Standard (with GMS) only.
	AppLock Administrator - Use to configure the Application Lock feature. This icon appears after the optional application is installed.
	MultiUser Administrator - Use to configure the MultiUser feature. This icon appears after the optional application is installed.
	Secure Storage Administrator - Use to configure the Secure Storage feature. This icon appears after the optional application is installed.

Accessing Applications

All applications installed on the device are accessed using the **APPS** window.

Procedure:

- 1 On the Home screen, touch .
- 2 Slide the **APPS** window left or right to view more application icons. Touch an icon to open the application.



Note: See [Application Shortcuts and Widgets on page 47](#) for information on creating a shortcut on the Home screen.

Switching Between Recent Applications

Procedure:

- 1 Touch and hold  (non-GMS devices) or  (GMS devices). A window appears on the screen with icons of recently used applications.

Figure 45: Recently Used Applications

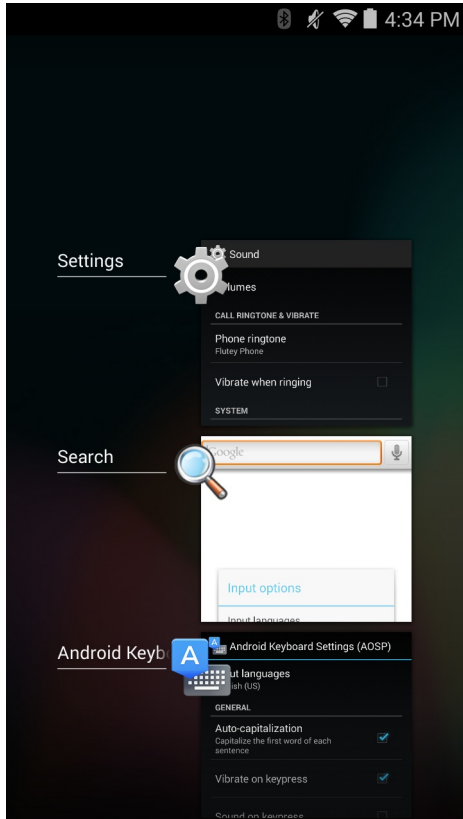

- 2 Slide the window up and down to view all recently used applications.
- 3 Swipe left or right to remove application from the list and force close the application.
- 4 Touch an icon to open it or  to return to the current screen.



Un-Locking the Screen

Use the Lock screen to protect access to data on the TC75. Some email account require locking the screen. Refer to the *TC75 Integrator Guide* for information on setting up the locking feature. The Locking feature functions differently in Single User mode or Multiple User mode.

Single User Mode

When locked, a pattern, PIN or password is required to unlock the device. Press the Power button to lock the screen. The device also locks after a pre-defined time-out.

Press and release the Power button to wake the device.

The Lock screen displays. Slide  to the right toward  to unlock the screen.

If the Pattern screen unlock feature is enabled, the Pattern screen appears instead of the Lock screen.

If the PIN or Password screen unlock feature is enabled, enter the PIN or password after unlocking the screen.

Figure 46: Lock Screen

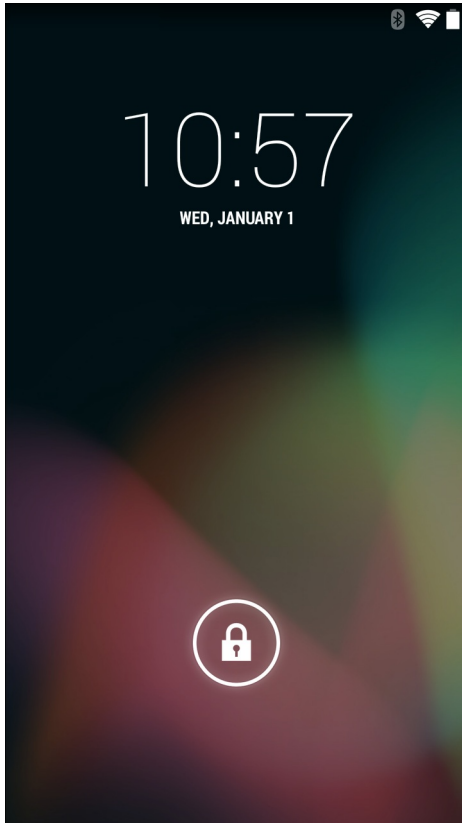

Figure 47: PIN Screen

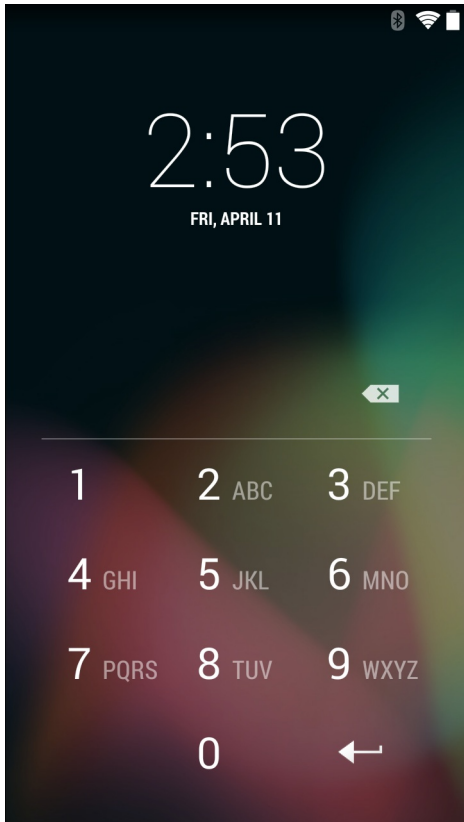

Figure 48: Pattern Screen

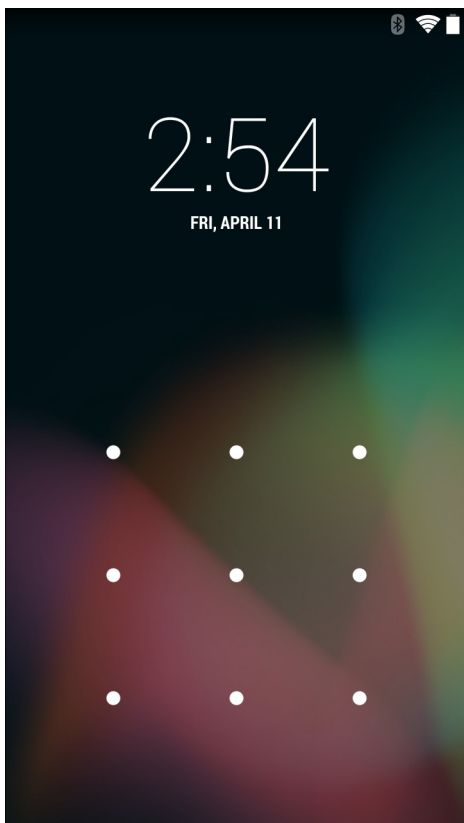
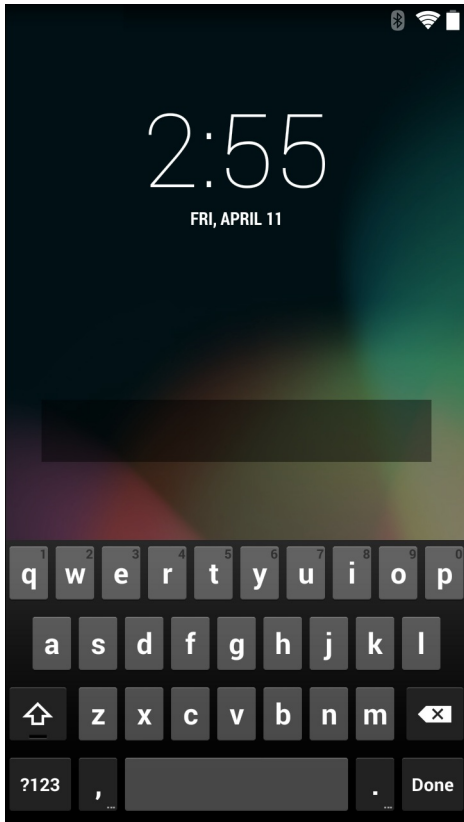

Figure 49: Password Screen

MultiUser Mode

With MultiUser login, multiple users can log on to the device with each user having access to various applications and features. When enabled, the Login screen appears after powering on, resetting or after the device wakes from suspend mode.

MultiUser Login

Procedure:

- 1 In the **Login** text field, enter the username.

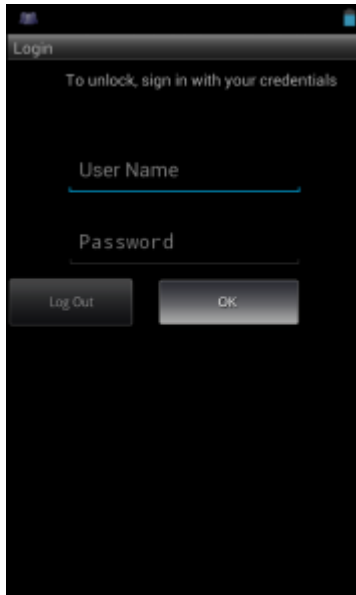
Figure 50: Multiple User Log In Screen

- 2 In the **Password** text field, enter the password.
- 3 Touch **OK**. After a resume from suspend, the user must enter the password.

MultiUser Logout

Procedure:

- 1 Drag the Status Bar down from the top of the screen.
- 2 Touch **MultiUser is active**.
- 3 Touch **Logout**.
- 4 The **Login** screen appears.

Resetting the Device

There are two reset functions, soft reset and hard reset.

Performing a Soft Reset

Perform a soft reset if applications stop responding.

Procedure:

- 1 Press and hold the Power button until the menu appears.
- 2 Touch **Reset**.
- 3 The device reboots.

Performing a Hard Reset



Caution: Performing a hard reset with a SD card installed in the TC75 may cause damage or data corruption to the SD card.

Perform a hard reset if the TC75 stops responding.



Procedure:

- 1 Simultaneously press the Power, Scan and Volume Up buttons for at least four seconds.
- 2 When the screen turns off, release the buttons.
- 3 The TC75 reboots.

Suspend Mode

The TC75 goes into suspend mode when the user presses the Power button or after a period of inactivity (set in the Display settings window).

To wake the TC75 from Suspend mode, press the Power button.

The Lock screen displays. Slide  to the right toward  to unlock the screen. If the Pattern screen unlock feature is enabled, the Pattern screen appears instead of the Lock screen. See [Un-Locking the Screen on page 55](#).



Note:

If the user enters the PIN, password or pattern incorrectly five times, they must wait 30 seconds before trying again.

If the user forgets the PIN, password or pattern contact the system administrator.

Figure 51: Lock Screen

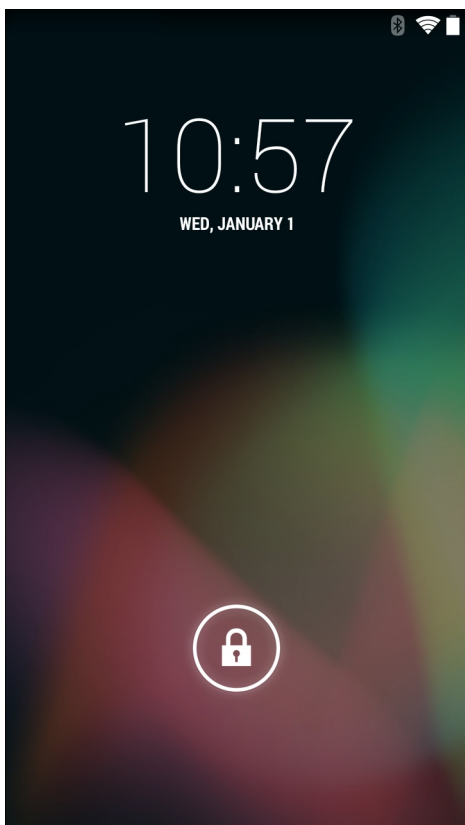

Chapter

3

Calls

Make a phone call from the **Phone** application, the **People** application or other applications or widgets that display contact information.

Emergency Calling

The service provider programs one or more emergency phone numbers, such as 911 or 999, that the user can call under any circumstances, even when the phone is locked, a SIM card is not inserted or the phone is not activated. The service provider can program additional emergency numbers into the SIM card. However, the SIM card must be inserted in the device in order to use the numbers stored on it. See the service provider for additional information.



Note: Emergency numbers vary by country. The phone's pre-programmed emergency number(s) may not work in all locations, and sometimes an emergency call cannot be placed due to network, environmental, or interference issues.

Audio Modes

The device offers three audio modes for use during phone calls:

- **Handset Mode:** Switches audio to the receiver at the top front of the device, so the user can use the device as a handset. This is the default mode.
- **Speaker Mode:** Use the device as if on speaker phone.
- **Headset Mode:** Connect a Bluetooth or wired headset to automatically switch audio to the headset.

Using a Bluetooth Headset

Use a Bluetooth headset for audio communication when using an audio-enabled application. See [Bluetooth on page 130](#) for information on connecting a Bluetooth headset to the device. Set the volume appropriately before putting on the headset. When a Bluetooth headset is connected, the speakerphone is muted.

Using a Wired Headset

Use a wired headset and Audio Adapter for audio communication when using an audio-enabled application. Set the volume appropriately before putting on the headset. When a wired headset is connected, the speakerphone is muted.

Lift the headset cover and insert the headset plug.

To end a call using the wired headset, press and hold the headset button until the call ends.

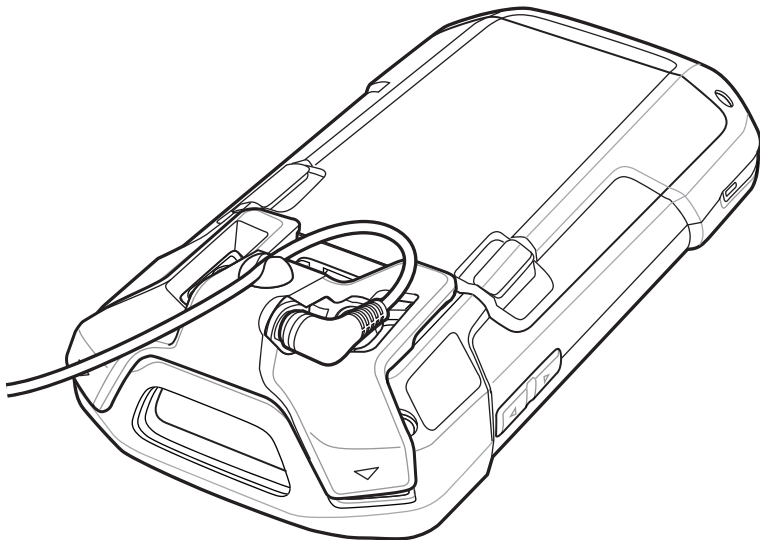
Figure 52: Insert Wired Headset Plug (2.5 mm Adapter Shown)

Adjusting Audio Volume

Use the Volume buttons to adjust the volume of the ringer when not in a call and the audio volume when in a call.



Note: Adjust the conversation phone volume during a call. Adjusting the volume while not in a call affects the ring and notification sound levels.

Making a Call Using the Dialer

Use the dialer tab to dial phone numbers.

Procedure:

1

On the Home screen touch



Figure 53: Dialer Screen (JellyBean)

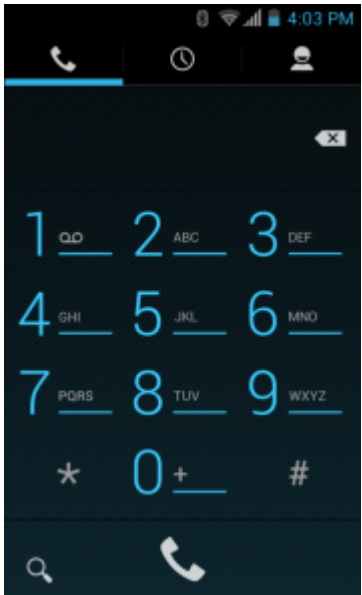
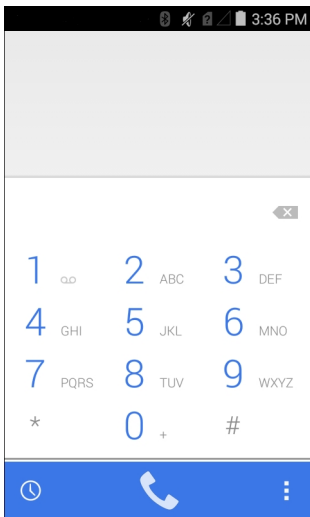

Figure 54: Dialer Screen (KitKat)













- 2  Touch the  tab above the dialer.
- 3 Touch the keys to enter the phone number.
- 4  Touch  below the dialer to initiate the call.

Figure 55: Call in Progress

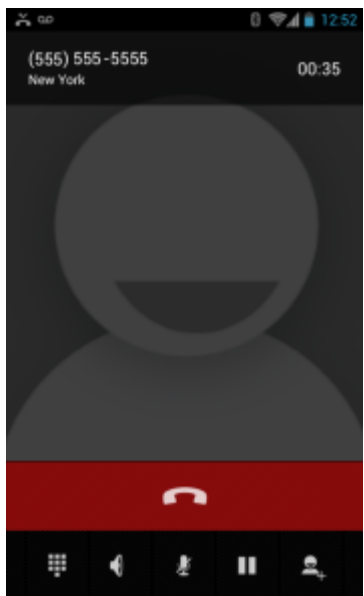



If...	Then...
You want to display the dialer.	Touch  .
You want to turn on the speakerphone.	Touch  .
You want to mute the call.	Touch  .
You want to place the call on hold.	Touch  .
You want to add another person to the call.	Touch  .

5

Touch  to end the call.

Dialer Dialing Options

The dialer provides options to save the dialed number to contacts, insert pauses and wait into the dial string and options for setting the Call settings. Enter at least one digit to access these options. Touch  or  to access the following.

- **Add to contacts** – add the dialed number to the **People** application.
- **Add 2-sec pause** - pause the dialing of the next number for two seconds. Multiple pauses can be added sequentially.
- **Add wait** - wait for confirmation to send the rest of the digits.
- **Settings** - Opens the **Call settings** screen.

Making a Call Using Contacts

Procedure:





- 1 On the Home screen touch .
- 2 Touch the  tab.

Figure 56: Dialer Contacts Tab



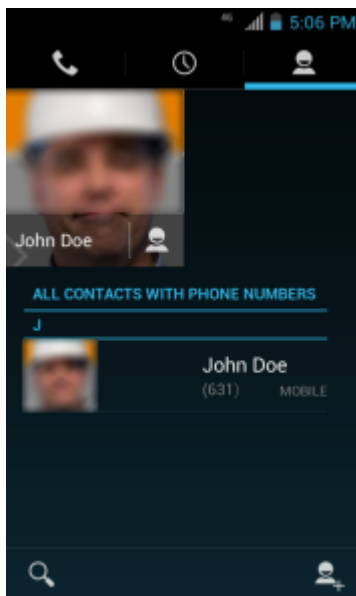

- 3 Touch the contact to initiate the call.
- 4 Touch  to end the call.

Making a Call Using Call History

Call History is a list of all the calls placed, received, or missed. It provides a convenient way to redial a number, return a call, or add a number to Contacts.

Arrow icons beside a call indicate the type of call. Multiple arrows indicate multiple calls:

-  - Missed incoming call
-  - Received incoming call
-  - Outgoing call.

Procedure:







- 1 On the Home screen touch .
- 2 Touch the  tab.

Figure 57: Call History Tab

- 3  Touch  next to the contact to initiate the call.
- 4  Touch  to end the call.

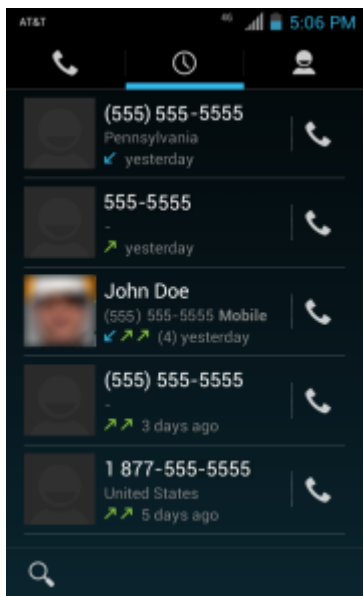
Making a Conference Call

To create a conference phone session with multiple people.



Note: Conference Calling and the number of conference calls allowed may not be available on all services. Please check with the service provider for Conference Calling availability.

Procedure:













- 1  On the Home screen touch .
- 2  Touch the  tab above the dialer.
- 3  Touch the keys to enter the phone number.
- 4  Touch  below the dialer to initiate the call.
- 5  When the call connects, touch . The first call is placed on hold.
- 6  Touch the keys to enter the second phone number.
- 7  Touch  below the dialer to initiate the call.
- 8  When the call connects, the first call is placed on hold and the second call is active.

Figure 58: Two Calls



- 9 Touch  icon to create a conference call with three people.

Figure 59: Merged Calls

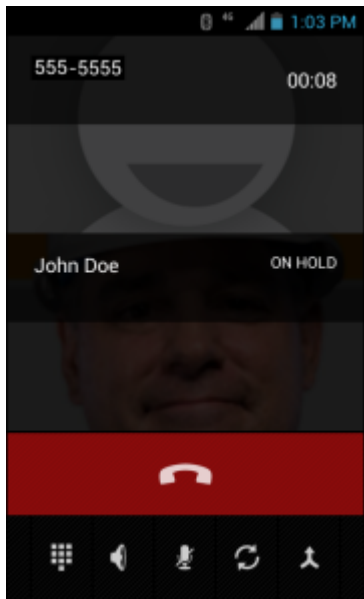



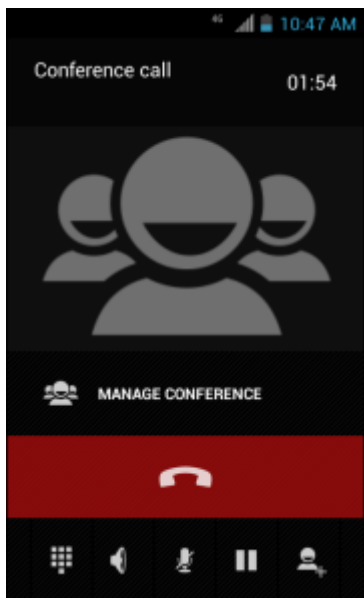

- 10 Touch  to add another call.
The conference is placed on hold.
- 11 Touch the keys to enter the second phone number.
- 12 Touch  below the dialer to initiate the call.
- 13 Touch  icon to add the third call to the conference.
- 14 Touch **Manage Conference** to view all callers.

Figure 60: Un-merge Calls

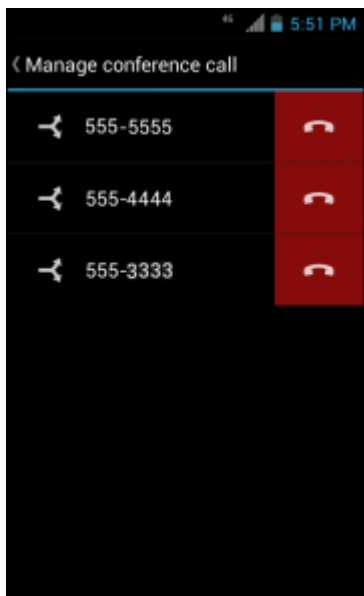

15

To remove a caller from the conference, touch  next to the caller.



Note: To speak privately with one party during a conference call, touch **Manage Conference** and then touch the caller. To include all parties again, touch .

Making a Call Using a Bluetooth Headset

Procedure:

- 1 Pair the Bluetooth headset with the device.
- 2 Press the Call button on the Bluetooth headset.
“Speak now” is heard from the Bluetooth headset and the **Voice Dialer** screen appears.
- 3 Say a command.

If...	Then...
You want to call a contact by name:	Say “Call <i>(name)</i> .”
You want to call a number:	Say “Dial <i>(number)</i> .”
If you want to call your voicemail:	Say “Call voicemail.”
If you want to call the previous caller:	Say “Redial.”

- 4 Press the Call button on the Bluetooth headset to end the call.

Answering Calls

When you receive a phone call, the **Incoming Call** screen opens, displaying the caller ID and any additional information about the caller that is in the **People** application.

Figure 61: Incoming Call Screen

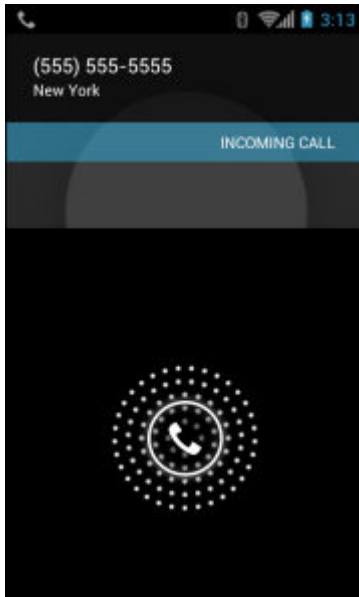



All incoming calls are recorded in the **Phone** application Call log tab. If you miss a call, you receive a notification. To silence the ringer before answering the call, press the volume down button on the side of device.

When a call arrives, touch the white phone icon and slide over one of these icons:

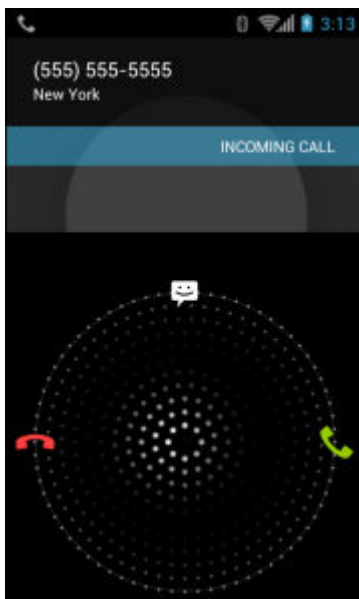
Figure 62: Select Answer Options



-  Answer call - Start talking to the caller.
-  Send to voice mail - Direct the caller to leave a voice mail message.
-  Send a message - Opens a list of quick text responses. Touch one to send it to the caller immediately.

Answering Calls with a Bluetooth Headset

When you receive a phone call, the **Incoming Call** screen opens, displaying the caller ID and any additional information about the caller that is in the **People** application.

Figure 63: Incoming Call Screen

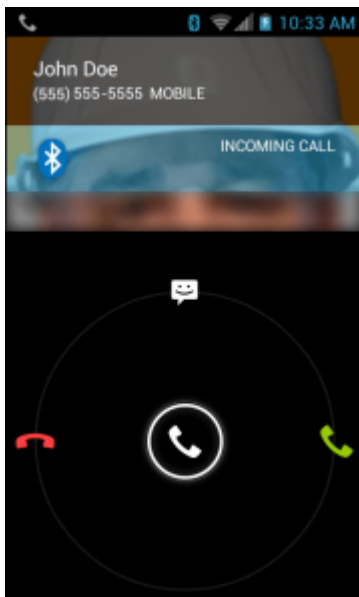

All incoming calls are recorded in the **Phone** application Call log tab. If you miss a call, you receive a notification. To silence the ringer before answering the call, press the volume down button on the side of the device.

When a call arrives, touch the Call button on the Bluetooth headset to answer the call..

To end the call press the Call button on the Bluetooth headset.

Call Settings



Note: Not all options are available for all configurations.

Use the Call Settings to modify options related to the phone call feature.

- **Ringtone & Vibrate**
 - **Phone ringtone** - Touch to select a ringtone to sound when an incoming call is received.
 - **Vibrate when ringing** - Check to make the device vibrate when a call is received.
- **Other Call Settings**
 - **Voicemail** - Touch to configure voicemail settings.
 - + **Service** - Set the service provider or other provider for voicemail service.
 - + **Setup** - Touch to update the phone number used to access voicemail.
 - + **Sound** - Touch to select a sound to play when a voicemail is received.
 - + **Vibrate** - Set vibrate option. (default – disabled).
 - **Dial pad touch tones** - Check to play a sound when a phone key is touched.
 - **Quick responses** - Touch to edit quick responses to use instead of answering a call.

- **Fixed Dialing Numbers** - Use Fixed Dialing to restrict the phone to dial only the phone number(s) or area code(s) specified in a Fixed Dialing list.
- **TTY mode** - Touch to set the TTY setting. Use an optional teletypewriter (TTY) device with the TC75 to send and receive calls. Plug the TTY device into the TC75 headset jack and set the TC75 to operate in one of the TTY modes.



Note:

Use a TSB-121 compliant cable (provided by the TTY manufacturer) to connect the TTY device to the TC75.

Set the TC75 volume to a middle level setting for proper operation. If you experience a high number of incorrect characters, adjust the volume as needed to minimize the error rate.

For optimal performance, the TC75 should be at least 30 cm (12 inches) from the TTY device. Placing the TC75 too close to the TTY device may cause high error rates.

- + **TTY off** (default) - TTY is off.
- + **TTY Full** - Transmit and receive TTY characters.
- + **TTY HCO** - Transmit TTY characters but receive by listening to earpiece.
- + **TTY VCO** - Receive TTY characters but transmit by speaking into microphone.
- **DTMF tones** - Touch to set the length of the DTMF tones. Options: **Normal** (default) or **Long**.
- **GSM call settings**
 - + **Call forwarding** - Use call forwarding to forward incoming calls to a different phone number.



Note: Call Forwarding may not be available on all networks. Check with the service provider for availability.

- **Always forward** - set to forward all calls to a different phone number.
- **Forward when busy** - enter the phone number to forward calls only when the line is busy.
- **Forward when unanswered** - enter the phone number to forward calls only when the phone cannot be answered.
- **Forward when unreachable** - enter the phone number to forward calls only when the phone is turned off or the user is unreachable.
- + **Call barring** - Use call barring to block certain types of incoming and/or outgoing calls. Select the type of incoming and/or outgoing calls to block.
- + **Additional settings**
 - **Caller ID** - Enable caller ID to reveal the identity of the person making an outgoing call. Options: **Network default** (default), **Hide number**, **Show number**.
 - **Call waiting** - Check to enable.
- **CDMA call settings (not supported)**
 - **Voice privacy** – Enable enhanced privacy mode.
- **Internet Call Settings**
 - **SIP Accounts** - Choose to receive Internet calls for accounts added to the device, view or change SIP accounts, or add an Internet calling account.
 - **Use Internet calling** - Use Internet calling for all calls, only for calls to Internet calling addresses (the default setting), or to ask for each call. Must be connected to a Wi-Fi network and have added an Internet calling account to the device to use Internet calling.
 - **IMS Account** - Select to enable or disable IMS Service capability.

Chapter 4

Applications

This section describes the applications installed on the device.

File Browser

Use the **File Browser** application to view and manage files on the device.





To open **File Browser**, touch  > .

Figure 64: File Browser Screen



The address bar (1) indicates the current folder path. Touch the current folder path to manually enter a path and folder name.

Use  (2) to select multiple files/folder.

Use  (3) to view the internal storage root folder.

Use  (4) to view the microSD card root folder.

Use  (5) to view the previous folder or to exit the application.

Touch and hold an item to perform an operation on that item. Select one of the options from the **File Operations** menu:

- **Information** - View detailed information about the file or folder.
- **Move** - Move the file or folder to a new location.
- **Copy** - Copy the select file.
- **Delete** - Delete the selected file.
- **Rename** - Rename the select file.
- **Open as** - Open the selected file as a specific file type.
- **Share** - Share the file with other devices.

Messaging

Use **Messaging** to send and receive SMS and MMS messages. From a Home or All Apps screen, touch .

Sending a Text Message

Procedure:

1

In the main **Messaging** screen, touch .

Figure 65: New Text Message Screen



2 In the **To** field, enter a name or a mobile phone number.

3 In the **Type message** field, enter the text message.

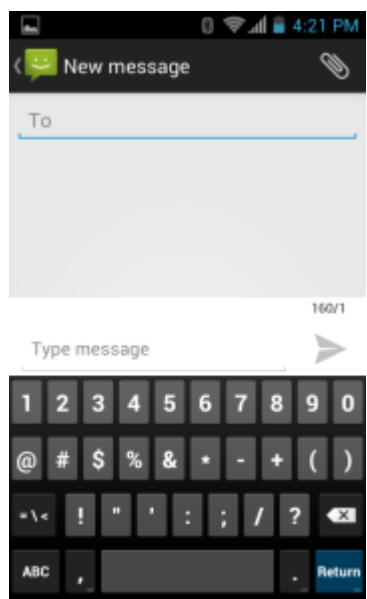
The 160-character limit counter indicates how many characters are left. If it goes over that limit, a new message is created, which is joined with its predecessors when received.

If the user presses the Back button while composing a message, it's saved as a draft in the **Messaging** screen. Touch the conversation to resume composing it.

4

Touch  to send the message.

Sending a Multimedia Message

Procedure:

1



In the main **Messaging** screen, touch .

Figure 66: New Multimedia Message Screen

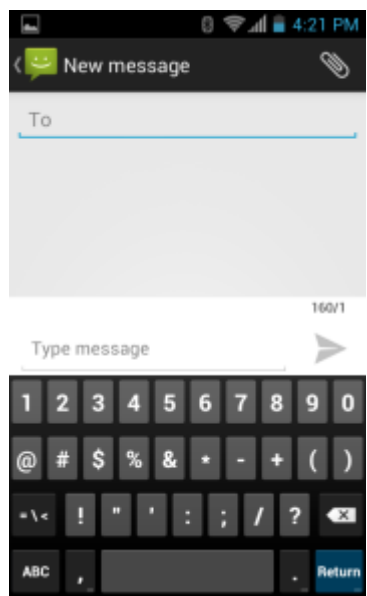

2 In the **To** field, enter a name or a mobile phone number.

3

Touch  to attach the media file of your choice:

- **Pictures.** Select a picture to attach.
- **Capture picture.** Camera opens to take a picture and attach it.
- **Videos.** Select a video to attach.
- **Capture video.** Camcorder opens to record a video and attach it to the message.
- **Audio.** Choose a sound file to attach.
- **Record audio.** Sound Recorder opens to record a spoken message and attach it to the message.
- **Slideshow.** Opens a screen opens to assemble text, photos, videos, and recordings into a slideshow of up to 10 slides to attach to the message.
- **Contacts.** Send a contact's information.

4

Touch  to send the message.

People

Use the **People** application to manage contacts.

From a Home or **Apps** screen, touch . **People** opens to the main list of contacts. View contacts in three ways at the top of the screen: Groups, All contacts, and Favorites. Touch the tabs to change how to view the contacts. Swipe up or down to scroll through the lists.



Adding People

Procedure:

- 1 In the **People** application, touch .
- 2 If there are more than one account with contacts, touch the one to use.
- 3 Type the contact's name and other information. Touch a field to start typing, and swipe down to view all categories.
- 4 To add more than one entry for a category – for example, to add a work address after typing a personal address – touch **Add new** for that field. To open a menu with preset labels, such as Home or Work for an email address, touch the label to the right of the item of contact information. Or, to create your own label, touch **Custom** in the menu.
- 5 Touch **Done**.

Editing People

Procedure:

- 1 In the **People** application, touch  tab.
- 2 Touch a person to edit.
- 3 Touch .
- 4 Touch **Edit**.
- 5 Edit the contact information.
- 6 Touch **Done**.

Deleting People

Procedure:

- 1 In the **People** application, touch  tab.
- 2 Touch a person to edit.
- 3 .
- 4 Touch **Delete**.
- 5 Touch **OK** to confirm.

Camera

This section provides information for taking photos and recording videos using the integrated digital cameras.



Note: If a microSD card is installed, The TC75 saves photos and videos on the microSD card. If a microSD card is not installed, the TC75 saves photos and videos on the internal storage.

Figure 67: Camera Photo Screen

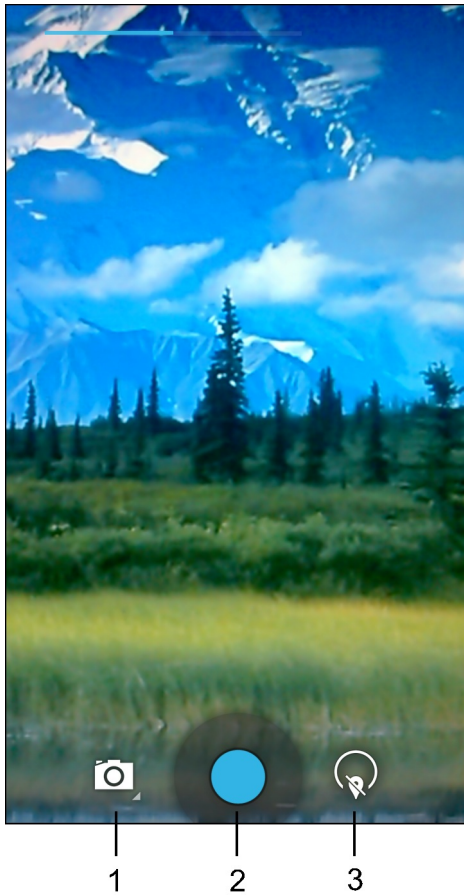

1	Camera Options — Touch to select Camera, Video or Panorama mode.
2	Shutter button - Touch to take a photo, a panoramic photo or to record a video.
3	Photo Settings – Touch to select camera settings.

Taking Photos



Note:

Camera settings are described in [Photo Settings on page 82](#).

Procedure:

- 1 Touch .
- 2 Touch .

Figure 68: Camera Mode





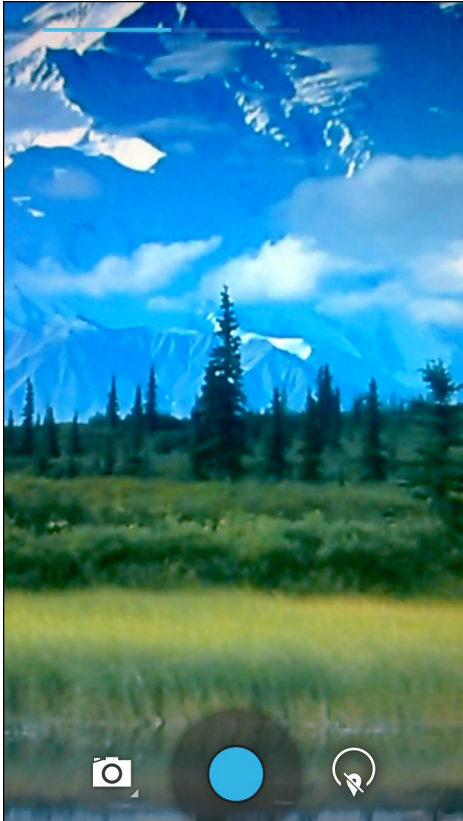

- 3 If necessary, touch the camera options icon and touch .
- 4 To switch between the rear camera and front camera, touch  and then  or .
- 5 Frame the subject on the screen.
- 6 To zoom in or out, press two fingers on the display and pinch or expand fingers. The zoom controls appear on the screen.

Figure 69: Camera Zoom

- 7 Touch an area on the screen to focus. The focus circle appears on the screen. The two horizontal bars turn green when in focus.
- 8 Touch .

The camera takes a photo and a shutter sound plays.

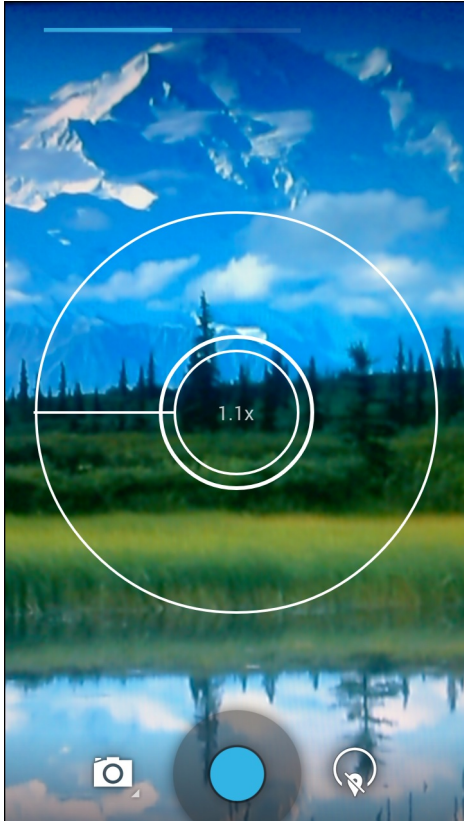
Alternately, touch  and hold to focus first, before taking a photo; then release to take a focused photo.

The photo momentarily displays as a thumbnail in the upper right corner.

Taking a Panoramic Photo

Panorama mode lets the user create a single wide image by panning slowly across a scene.

Procedure:





- 1 Touch .
- 2 Touch .

Figure 70: Panoramic Mode

3

Touch the options bar and touch .

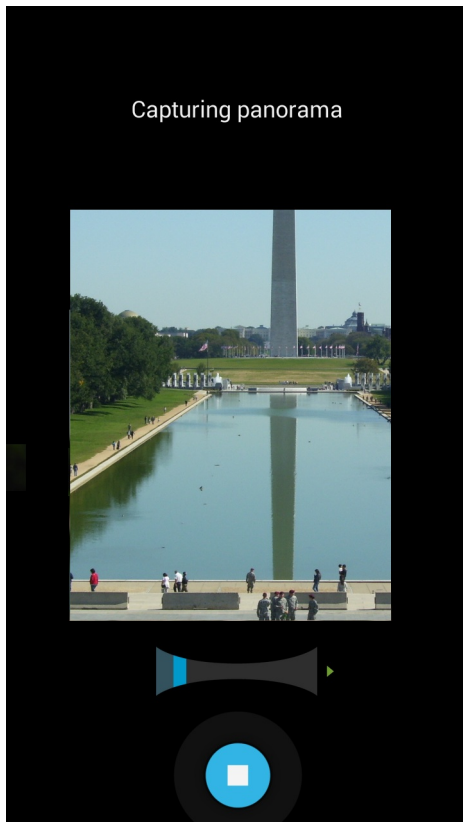
4 Frame one side of the scene to capture.

5 Touch  and slowly start panning across the area to capture. A small white square appears inside the button indicating the capture is in progress.

If panning too quickly, the message **Too fast** appears.

6 Touch  to end the shot. The panorama appears immediately and a progress indicator displays while it saves the image.

Recording Videos

To record a video:

Procedure:

1 Touch .

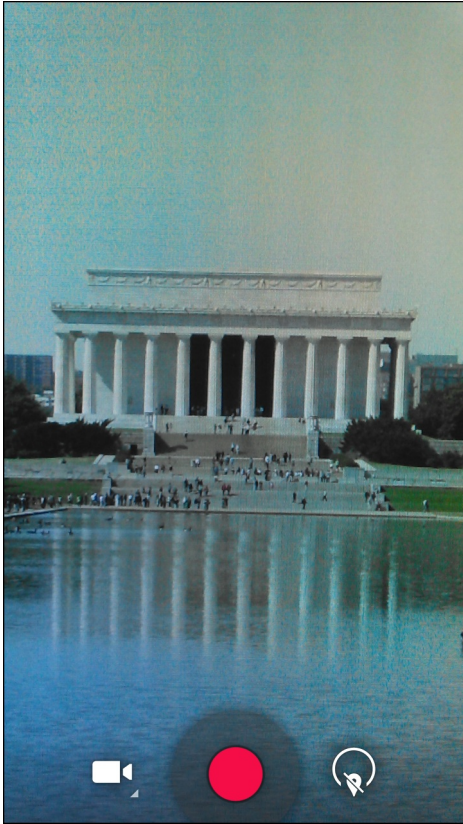

2 Touch .

Figure 71: Video Mode



3 Touch the options bar and touch .

4

To switch between the rear camera and front camera, touch  and then  or .

5 Point the camera and frame the scene.

6 To zoom in or out, press two fingers on the display and pinch or expand fingers. The zoom controls appear on the screen.

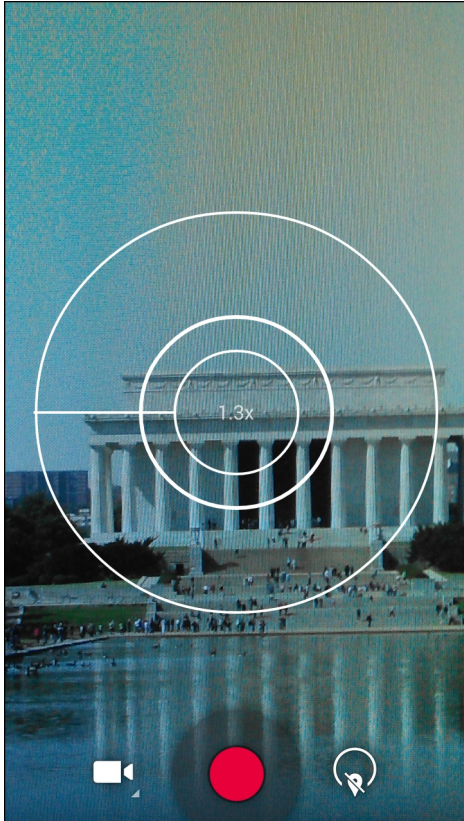
Figure 72: Camera Zoom

7 Touch  to start recording.

The device starts recording the video. The video time remaining appears in the top left of the screen.

8 Touch  to end recording.

The video momentarily displays as a thumbnail in the upper right corner.

Photo Settings

When in Photo mode, photo settings are displayed on screen. Touch  to display the photo settings options.

Rear Camera



Touch  to display the photo setting options.

Figure 73: Rear Photo Setting Options





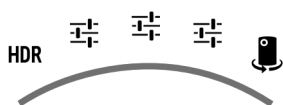



- **HDR** – Touch to enable High Dynamic Range (HDR) imaging. HDR adds more dynamic range to photographs (the ratio of light to dark). HDR uses three photos, taken at different exposures to create the photo (default - disabled).
- First :

- **Scene mode** - Touch to select a preset combination of camera settings designed for specific scenes. Options: **Auto** (default), **Night**, **Portrait**, **Landscape**, **Steady Photo**, **Sports** or **Document capture**.
- **Store location** – Touch to add location information to the photo. (default – disabled)
- **Picture size** - Touch to set the size (in pixels) of the photo. Options: **8M pixels** (default), **5M pixels**, **3M pixels**, **HD 1080p**, **2M pixels**, **HD 720p**, **1M pixels**, **WVGA**, **VGA** or **QVGA**.
- **Picture quality** - Touch to select picture quality setting. Options: **Super fine** (default), **Fine** or **Normal**.
- **ZSL** - Set the camera to immediately take a picture when the button is pressed (default – disabled)
- **Countdown timer** - Options: **Off** (default), **1 second**, **2 seconds**, **3 seconds**, **4 seconds**, **5 seconds**, **10 seconds**, **15 seconds**, **20 seconds**, **30 seconds** or **60 seconds**.
- **Beep during countdown** - Select to play a beep tone during countdown (default – enabled).

• Second :

- **Face detection** - Select to enable face detection (default – enabled).
- **Touch AF/AEC** - Select to enable auto focus (default – enabled).
- **Sharpness** - Touch to select a sharpness level. Options: **Level 0**, **Level 1**, **Level 2**, **Level 3** (default), **Level 4**, **Level 5** or **Level 6**.
- **Select Auto Exposure** - Touch to select auto exposure setting. Options: **Frame Average** (default), **Center Weighted** or **Spot Metering**.

• Third :

- **Anti Banding** - Options: **Off**, **50 Hz**, **60 Hz** or **Auto** (default).
- **Select ISO** - Set how sensitive the camera is to light. Options: **Auto** (default), **ISO Auto (HJR)**, **ISO100**, **ISO200**, **ISO400**, **ISO800** or **ISO1600**.
- **Exposure** - Touch to adjust the exposure settings. Options: **+2**, **+1**, **0** (default), **-1** or **-2**.
- **White balance** - Touch to select how Camera adjusts colors in different kinds of light, to achieve the most natural-looking colors.
 - +  **Incandescent** - Adjust the white balance for incandescent lighting.
 - +  **Fluorescent** - Adjust the white balance for florescent lighting.
 - +  **Auto** - Adjust the white balance automatically (default).
 - +  **Daylight** - Adjust the white balance for daylight.
 - +  **Cloudy** - Adjust the white balance for a cloudy environment.
- **Flash mode** - Touch to set whether Rear-facing Camera relies on its light meter to decide whether a flash is necessary, or to turn it on or off for all shots.
 - +  **Off** - Disable flash.
 - +  **Auto** - Camera adjusts flash automatically depending upon light meter (default).
 - +  **On** - Enable flash upon taking a photo.
 - +  **Torch** - Turn flash on continuously.
- **Focus Mode** - Touch to select the camera focus setting. Options: **Auto** (default), **Infinity**, **Macro** or **CAF** (Continuous Auto Focus).
- **AE-Bracket** - Touch to set Automatic Exposure Bracketing (default – disabled).







– Touch to switch to the front camera.

Front Camera

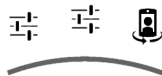

Touch to display the photo setting options.

Figure 74: Front Photo Setting Options

- First :
 - **Store location** – Touch to add location information to the photo. (default – disabled)
 - **Picture size** - Touch to set the size (in pixels) of the photo. Options: **HD 720p** (default), **1M pixels**, **WVGA**, **VGA** or **QVGA**.
 - **Picture quality** - Touch to select picture quality setting. Options: **Super fine** (default), **Fine** or **Normal**.
 - **Countdown timer** - Options: **Off** (default), **1 second**, **2 seconds**, **3 seconds**, **4 seconds**, **5 seconds**, **10 seconds**, **15 seconds**, **20 seconds**, **30 seconds** or **60 seconds**.
 - **Beep during countdown** - Select to play a beep tone during countdown (default – enabled).
- Second :
 - **Face detection** - Select to enable face detection (default – enabled).
- 
 - Touch to switch to the rear camera.

Video Settings

When in Video mode, video settings are displayed on screen. Touch  to display the video settings options.

Rear Camera









Touch  to display the photo setting options.

Figure 75: Rear Video Setting Options

- First :
 - **Time lapse** - Touch to select a time interval to set the frame rate for time lapse photography. Options: **Off** (default), Slide switch to **ON** and then set time interval.
 - **Video quality** - Touch to select video quality:
 - + **HD 1080p** - High definition 1080p (default).
 - + **HD 720p** - High definition 720p.
 - + **SD 480p** - Standard definition 480p.
 - **Video duration** - Options: **30 seconds (MMS)** or **30 minutes** (default).
 - **Store location** – Touch to add location information to the photo. (default – disabled)
- Second :
 - **White balance** - Touch to select how Camera adjusts colors in different kinds of light, to achieve the most natural-looking colors.
 - +  **Incandescent** - Adjust the white balance for incandescent lighting.

- +  **Fluorescent** - Adjust the white balance for florescent lighting.
- +  **Auto** - Adjust the white balance automatically (default).
- +  **Daylight** - Adjust the white balance for daylight.
- +  **Cloudy** - Adjust the white balance for a cloudy environment.
- **Flash mode** - Select to turn on flash (default – disabled).

-  – Touch to switch to the front camera.

Front Camera



Touch  to display the photo setting options.

Figure 76: Front Video Setting Options

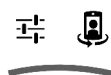

- 
 - **Time lapse** - Touch to select a time interval to set the frame rate for time lapse photography. Options: **Off** (default), Slide switch to **ON** and then set time interval.
 - **Video quality** - Touch to select video quality:
 - + **HD 720p** - High definition 720p (default).
 - + **SD 480p** - Standard definition 480p.
 - **Video duration** - Options: **30 seconds (MMS)** or **30 minutes** (default).
 - **Store location** – Touch to add location information to the photo. (default – disabled)
-  – Touch to switch to the rear camera.

Gallery





Note:

The device supports the following image formats: jpeg, gif, png and bmp.

The device supports the following video formats: H.263, H.264 and MPEG4 Simple Profile.

Use **Gallery** to:

- view photos
- play videos
- perform basic editing of photos
- set photos as wallpaper
- set photos as a contact photo
- share photos and videos.

To open the Gallery application, touch  >  or in the camera application touch the thumbnail image at the top right.

Gallery presents all photos and videos stored on the microSD card and internal memory.

Figure 77: Gallery — Albums

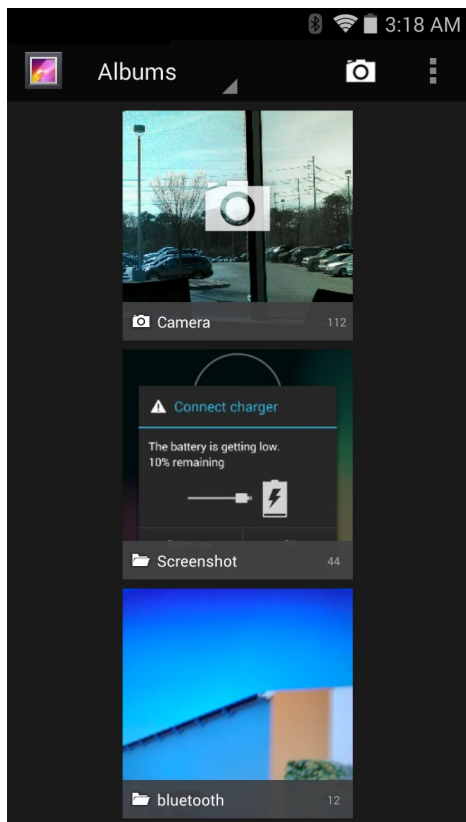

- Touch an album to open it and view its contents. The photos and videos in the album are displayed in chronological order.
- Touch a photo or video in an album to view it.
- Touch  to return to the main **Gallery** screen.

Working with Albums

Albums are groups of images and videos in folders. Touch an album to open it. The photos and videos are listed in a chronologically ordered grid. The name of the album displays at the top of the screen.



Figure 78: Photos Inside an Album



Swipe left or right to scroll images across the screen.

Share an Album

Procedure:

- 1 Touch .
- 2 Touch .
- 3 Touch and hold an album until it highlights.
- 4 Touch other albums as required.
- 5 Touch . The Share menu opens. Touch the application to use to share the selected albums.
- 6 Follow the instructions within the selected application.

Get Album Information

Procedure:



- 1 Touch .
- 2 Touch .
- 3 Touch and hold an album until it highlights.

- 4 Touch .
- 5 Touch **Details**.

Deleting an Album

To delete an album and its contents:

Procedure:

- 1 Touch .
- 2 Touch .
- 3 Touch and hold an album until it highlights.
- 4 Check other albums to delete. Ensure that other albums are selected.
- 5 Touch  > **Delete**.
- 6 In the **Delete selected item?** menu, touch **OK** to delete the album.

Working with Photos

Use **Gallery** to view photos on the microSD card and edit and share photos.

Viewing and Browsing Photos

To view a photo:

Procedure:



- 1 Touch .
- 2 Touch .
- 3 Touch an album to open it.
- 4 Touch a photo.

Figure 79: Photo Example



- 5 Swipe left or right to view the next or previous photo in the album.
- 6 Turn the device to view the photo in upright (portrait) or sideways (landscape) orientation. The photo is displayed (but not saved) in the new orientation.
- 7 Touch the photo to view the controls.
- 8 Double-tap the screen to zoom in or pinch two fingers together or spread them apart to zoom in or out.
- 9 Drag the photo to view parts that are not in view.

Cropping a Photo

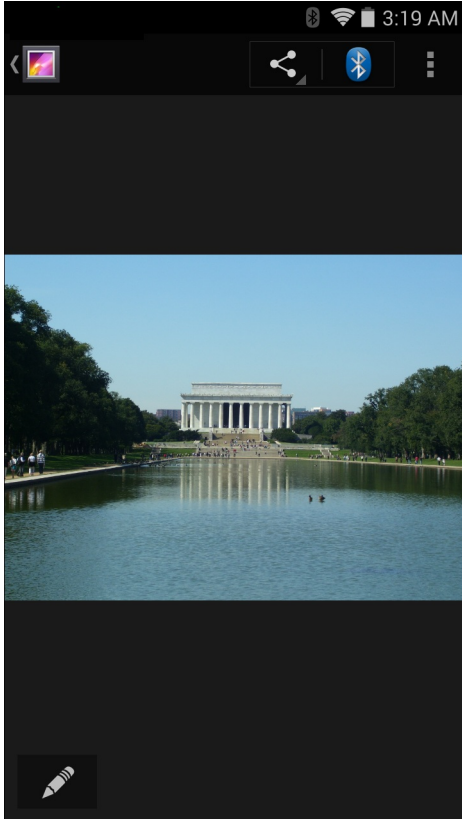
Procedure:





- 1 In **Gallery**, touch a photo to view the controls.
- 2 Touch .
- 3 Touch **Crop**. The cropping tool appears.
- 4 Use the cropping tool to select the portion of the photo to crop.
 - Drag from the inside of the cropping tool to move it.
 - Drag an edge of the cropping tool to resize it to any proportion.
 - Drag a corner of the cropping tool to resize it with fixed proportions.

Figure 80: Cropping Tool

- 5 Touch **Save** to save a copy of the cropped photo. The original version is retained.

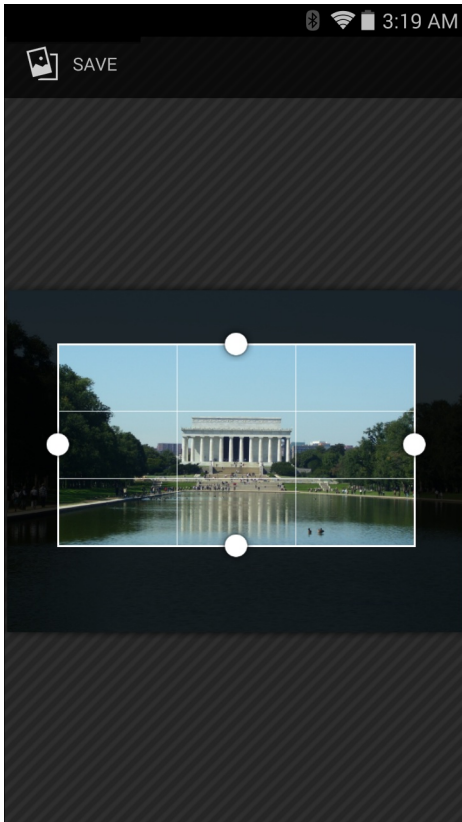
Setting a Photo as a Contact Icon

Procedure:

- 1 Touch .
- 2 Touch .
- 3 Touch an album to open it.
- 4 Touch the photo to open it.
- 5 Touch .
- 6 Touch **Set picture as**.
- 7 Touch **Contact photo**.
- 8 In the **People** application, touch a contact.
- 9 Touch the blue box and crop the photo accordingly.
- 10 Touch **OK**.

Share a Photo

Procedure:

- 1 Touch .
- 2 Touch .

3 Touch an album to open it.

4 Touch a photo to open it.

5



Touch

6 Touch the application to use to share the selected photo. The application selected opens with the photo attached to a new message.

Deleting a Photo

Procedure:

1

Touch .

2

Touch .

3 Touch an album to open it.

4 Touch a photo to open it.

5

Touch .

6 Touch **Delete**.

7 Touch **OK** to delete the photo.

Working with Videos

Use **Gallery** to view videos and share videos.

Watching Videos

Procedure:

1

Touch .



2

Touch .

3 Touch an album to open it.

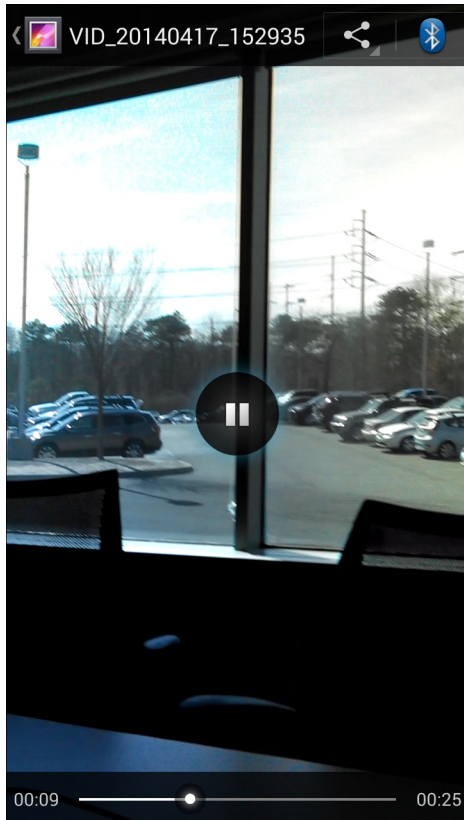



4 Touch a video.

Figure 81: Video Example

- 5  Touch . The video begins to play.
- 6 Touch the screen to view the playback controls.

Sharing a Video





Procedure:

- 1 Touch .
- 2 Touch .
- 3 Touch an album to open it.
- 4 Touch a video to open it.
- 5  Touch . The Share menu appears.
- 6 Touch the application to use to share the selected video. The application selected opens with the video attached to a new message.

Deleting a Video

Procedure:

- 1 Touch .

- 2  Touch .
- 3 Touch an album to open it.
- 4 Touch a video to open it.
- 5  Touch .
- 6 Touch **Delete**.
- 7 Touch **OK**.

DataWedge Demonstration



Note: DataWedge is enabled when on the Home screen displays. To disable this feature, go to the DataWedge settings and disable the **Launcher** profile.

Use **DataWedge Demonstration** to demonstrate data capture functionality.

Figure 82: DataWedge Demonstration Window

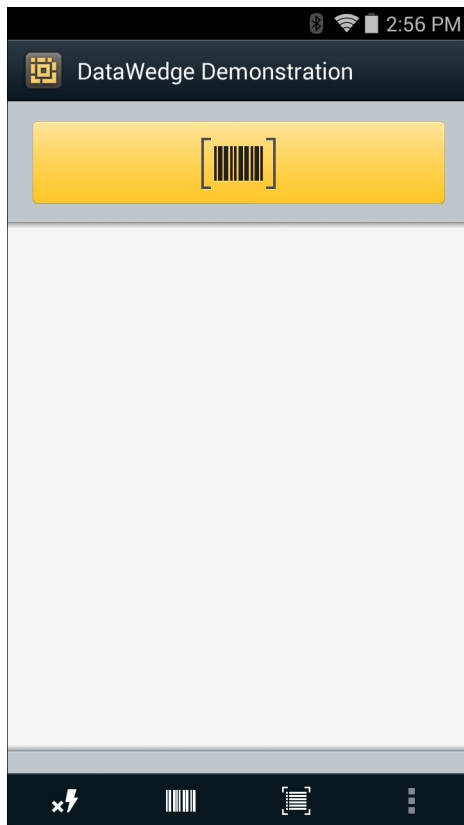





Table 9: DataWedge Demonstration Icons

Icon	Description
	Not applicable.

Table continued...

Icon	Description
	Indicates that the data capture function is through the imager.
	Toggles between normal scan mode and picklist mode when using the imager to capture bar code data.
	Opens a menu to view the application information or to set the application DataWedge profile.

**Note:**

See the *TC75 Integrator Guide* for information on DataWedge configuration.

Either press the programmable button or touch the yellow scan button to enable data capture. The captured data appears in the text field below the yellow button.

Sound Recorder

Use **Sound Recorder** to record audio messages.

Recordings are saved on the microSD card (if installed) or the Internal Storage and available in the Music application playlist titled "My Recordings."

Figure 83: Sound Recorder Application

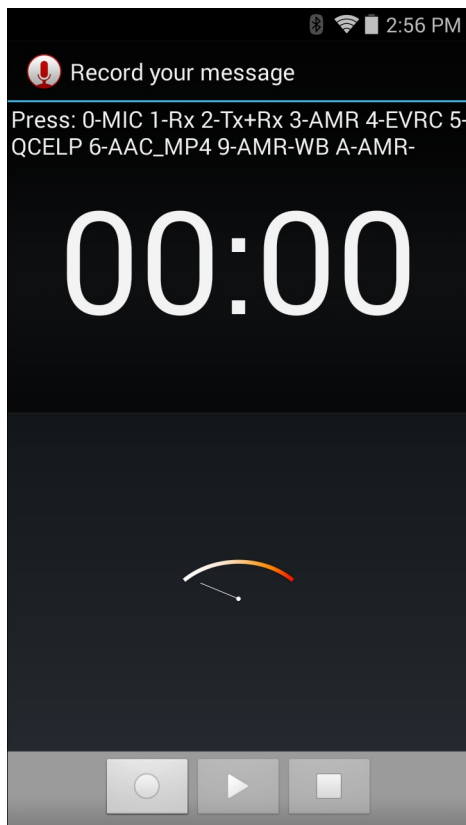

PTT Express Voice Client



Note:

PTT Express Voice Client creates Push-To-Talk (PTT) communication capability between disparate enterprise devices. Leveraging existing Wireless Local Area Network (WLAN) infrastructure, PTT Express delivers simple PTT communication without the need of a voice communication server.

- **Group Call:** Press and hold the PTT (Talk) button to start communicating with other voice client users.

PTT Audible Indicators

The following tones provide helpful cues when using the voice client.

- **Talk Tone:** Double chirp. Plays when the Talk button is depressed. This is a prompt for the user to start talking.
- **Access Tone:** Single beep. Plays when another user just finished a broadcast or response. The user is now able to initiate a Group Broadcast or Private Response.
- **Busy Tone:** Continuous tone. Plays when the Talk button is depressed and another user is already communicating on the same talkgroup. Plays after the maximum allowed talk time is reached (60 seconds).
- **Network Tone:**
 - Three increasing pitch beeps. Plays when PTT Express has acquired the WLAN connection and the service is enabled.
 - Three decreasing pitch beeps. Plays when PTT Express has lost the WLAN connection or the service is disabled.

Table 10: PTT Express Default User Interface Descriptions

Item	Description
Notification Icon	Indicates the current state of the PTT Express client.
Service Indication	Indicates the status of the PTT Express client. Options: Service Enabled , Service Disabled or Service Unavailable .
Talk Groups	Lists all 32 Talk Groups available for PTT communication.
Settings	Opens the PTT Express Settings screen.
Enable/Disable Switch	Turns the PTT service on and off.

Notification Icons

Indicates the current state of the PTT Express Voice client.

Table 11: PTT Express Default User Interface Descriptions









Status Icon	Description
	Indicates that PTT Express Voice client is disabled.
	Indicates that PTT Express Voice client is enabled but not connected to a WLAN.

Table continued...

Status Icon	Description
	Indicates that PTT Express Voice client is enabled, connected to a WLAN and listening on the Talk Group indicated by the number next to the icon.
	Indicates that PTT Express Voice client is enabled, connected to a WLAN and communicating on the Talk Group indicated by the number next to the icon.
	Indicates that PTT Express Voice client is enabled, connected to a WLAN and in a private response.
	Indicates that PTT Express Voice client is enabled and muted.
	Indicates that the PTT Express Voice client is enabled but it is not able to communicate due to a VoIP telephony call is in progress.

Enabling PTT Communication

Procedure:

- 1 Touch .
- 2 Touch .
- 3 Slide the **Enable/Disable Switch** to the **ON** position. The button changes to an **ON** button.

Selecting a Talk Group

One of 32 Talk Groups can be selected by PTT Express users. However, only one talk group may be enabled at a time on the device. Touch one of the 32 Talk Groups. The selected Talk Group is highlighted.

PTT Communication



Note: This section describes the default PTT Express client configuration. See the *PTT Express V1.2 User Guide* for detailed information on using the client.

PTT communication may be established as a Group Call. When PTT Express is enabled, the PTT button on the left side of the device is assigned for PTT communication. When the Wired Headset is used, Group Calls can also be initiated using the headset Talk button.

Figure 84: PTT Buttons

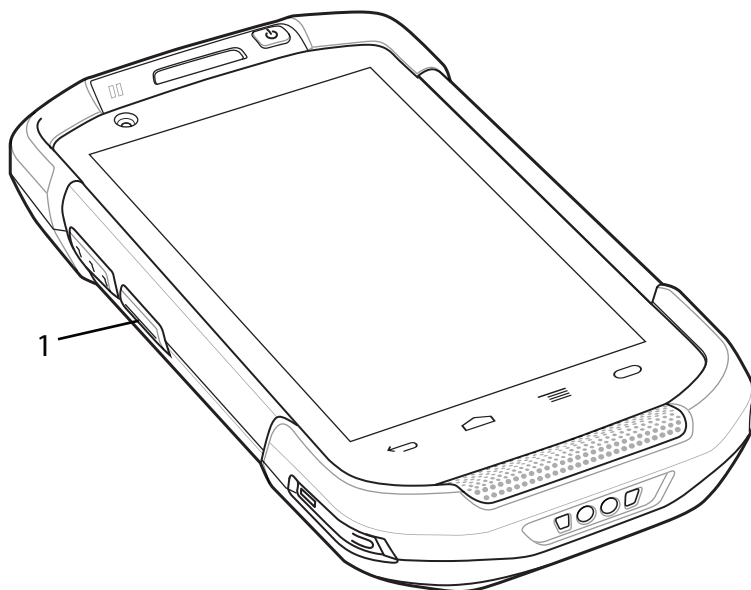

1	PTT Button
---	------------

Creating a Group Call

Procedure:

- 1 Press and hold the PTT button (or the Talk button on the headset) and listen for the talk tone to play. If a busy tone is heard, release the button and wait a moment before making another attempt. Ensure that PTT Express and the WLAN are enabled.
- 2 Start talking after the talk tone is heard.



Note: If the user holds the button for more than 60 seconds (default), the call is dropped allowing others to make Group calls. The user should release the button when finished talking to allow others to make calls.

- 3 Release the button when finished talking.

Disabling PTT Express Voice Client Communication

Procedure:

- 1 Touch
- 2 Touch
- 3 Slide the **Enable/Diable Switch** to the **OFF** position. The button changes to **OFF**.
- 4 Touch

MLog Manager

Use **MLog Manager** to capture log files for diagnostics. See the *TC75 Integrator Guide* for detailed information on configuring the application.

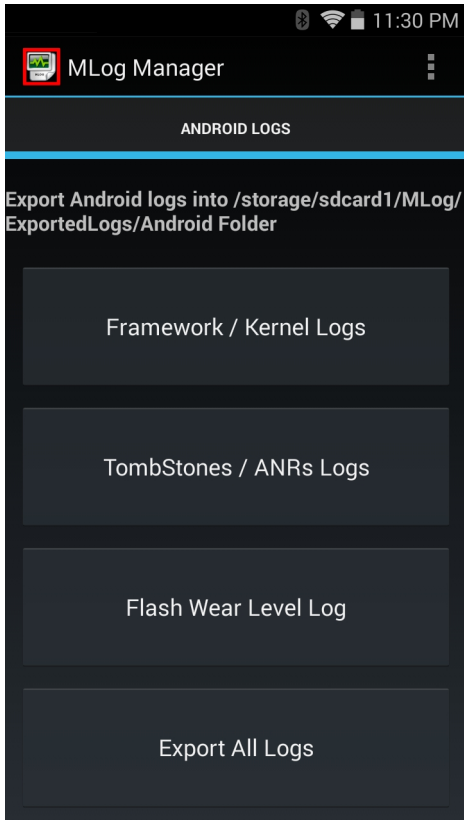
Figure 85: MLog Manager

SimulScan Demo

The SimulScan application is an out of the box demonstration application included on the device that support SimulScan. The application enables pre-sales personnel to showcase the various features of SimulScan to customers by employing use-cases in the two most popular verticals, Postal/Transportation and Logistics and Manufacturing. The Transportation and Logistics example showcases the OCR and OMR features. The Manufacturing example showcases the MultiCode 20 feature. SimulScan also allows customers to create templates using the Template Builder and then testing on the device.

Figure 86: SimulScan Demo Home Screen

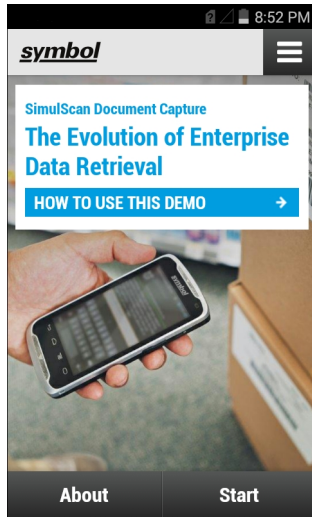

Exporting Sample Forms

In order to perform the Postal, Transportation & Logistics or Manufacturing demonstrations, print the example forms stored on the device.

Procedure:

- 1 Launch **SimulScan Demo** application.
- 2 On the **SimulScan Demo** home screen, touch **HOW TO USE THIS DEMO**.
- 3 Scroll down and touch **Export sample forms** button. The device copies the forms to the `\simulscan\samples` folder in Internal Storage.
- 4 Connect the device to a computer using the USB Charging cable.
- 5 Copy the files from the `\simulscan\samples` folder in Internal Storage to the computer.
- 6 Print the forms.

Postal, Transportation and Logistics Example

The Postal, Transportation and Logistics example uses the following form:.

Figure 87: Postal, Transportation and Logistics Form

1. Payer account number and insurance details		2. Non-Document Shipments Only (Customs Requirements)		5. Shipper's agreement	
Charge to <input checked="" type="checkbox"/> Shipper <input type="checkbox"/> Receiver <input type="checkbox"/> 3rd party <small>Not all payment options are available in all countries.</small> Payer Account No.: 001-12349876		Attach the original and four copies of a Proforma or Commercial Invoice Shipper's VAT/GST number: 564451112 Receiver's VAT/GST or Shipper's EIN/SSN: 1111577738 Harmonized Commodity Code if applicable:		(Signature required) <small>Unless otherwise agreed in writing, we agree to the Terms and Conditions of Carriage between the (1) sender and (2) carrier and (3) receiver and (4) shipper, where applicable, the Convention only and/or excluded liability for loss, damage or delay and (5) the agreement does not constitute each or all of the above.</small>  Signature _____ Date: 10 / 10 / 13 <small>For more information visit our website or call our local office.</small>	
Shipment Insurance (see reverse) <input checked="" type="checkbox"/> Via Insurance value (in local currency): 1400		Destination duties/taxes if not paid by receiver (see reverse): <input type="checkbox"/> Receiver <input type="checkbox"/> Shipper <input type="checkbox"/> Other _____ <small>Specify approved account number</small>			
3. From (Shipper)		4. To (Receiver)			
Shipper's account number: 155-22263 Company name: Pure Theory Ltd Address: 1638 Lansdown Drive, Fitzrovia, London, England, WC2 1AB Contact name: Scott Andrews Phone, Fax or E-mail (required): 0207 553633		Company name: TFW Solutions Delivery address: <small>We cannot deliver to a PO Box</small> Solvalla, Travbaneplan 12A 64 Bromma Postcode/Zip Code (required): 266 32 Country: Sweden Contact person: Aidan Peterson Phone, Fax or E-mail (required): +46 8 123 89 67			

Procedure:

- 1 Place the form on a flat surface.
- 2 On the device, launch **SimulScan Demo** application.
- 3 Touch the **Menu** icon in the top right corner of the screen.
- 4 Touch **Postal, Transportation & Logistics**.
- 5 Touch **Start SimulScan**.
- 6 Use the image control at the bottom of the screen to control the flash, audio and zoom level.

Figure 88: Image Controls



- 7 Position the camera over the form. Ensure that the complete border of the form is visible on the screen.
- 8 Hold the device steady.
- 9 Once the device detects the form **Tap Screen to Scan** appears on the screen.

10 Tap the screen to start the data capture. When completed, the device beeps and the data from the form displays.

Figure 89: Postal Data Screen

Field	Parsed Data
Barcode	123456-789A
Charge To	<input checked="" type="checkbox"/>
Account Number	155-22263
Shipper Name	Check Result Pure Theory Ltd
Shipper Address	Check Result 1631 LaDWS@Bwn Drive Fitzrovia, London

Buttons: Rescan, Accept

11 Touch the text boxes to correct any errors. Note: if there are too many errors, touch **Rescan** to perform the capture again.

12 Touch **Accept** to confirm the data is correct. The **Results summary** screen appears.

13 Touch **OK**.

Manufacturing Example

The Postal, Transportation and Logistics example uses the following form:

Figure 90: Manufacturing Form

reader <5 kgs MV unit

PART NUMBER (P) 5290261-69

SUPPLIER (S) 4305156059

QUANTITY (Q) 000128

PKG ID/SERIAL NUMBER (IS) X1 000114

MADE IN MEXICO

MANUFACTURING LTD

Procedure:

- 1 Copy the sample form from the device to a computer. See
- 2 Print this form.
- 3 Place the form on a flat surface.

- 4 On the device, launch **SimulScan Demo** application.
- 5 Touch the **Menu** icon in the top right corner of the screen.
- 6 Touch **Manufacturing**.
- 7 Touch **Start SimulScan**.
- 8 Point the top of the device at the document and center the target on the document.
- 9 Hold the device steady.
- 10 The device starts the data capture. When completed, the device beeps and the data from the document displays.

Figure 91: Manufacturing Data

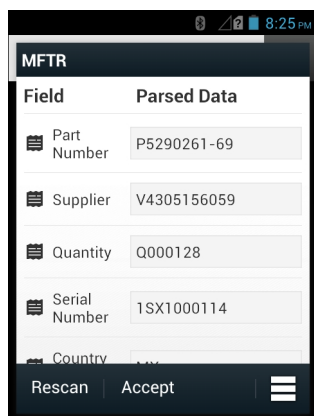

- 11 Touch the text boxes to correct any errors. If there are too many errors, touch **Rescan** to perform the capture again.
- 12 Touch **Accept** to confirm the data is correct. The **Results summary** screen appears.
- 13 Touch **OK**.

Settings

To set the settings for the **SimulScan Demo** application touch **Menu** icon > **Settings**.

Figure 92: Settings Screen

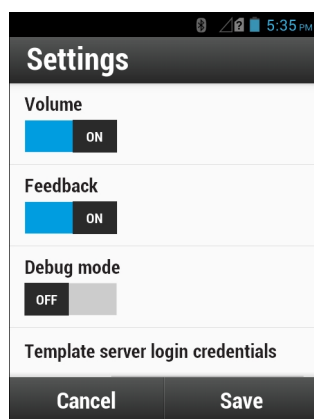

- **Volume** - Toggle switch to turn audible notification on and off.
- **Haptic** - Toggle switch to turn vibration notification on and off.
- **Debug mode** - Toggle switch to enable or disable debug mode.
- **Template server login credentials** - enter credentials for accessing the template server.

Advanced Settings

Use the Advanced setting to configure data capture options. In the data capture screen, touch  in the bottom right corner of the screen.

Figure 93: Advanced Settings Screen



- **Identification Timeout** - Set the amount of time to wait before timing out identifying the target document. Options: **2 seconds**, **5 seconds**, **10 seconds**, **15 seconds**, **20 seconds** or **25 seconds**.
- **Processing Timeout** - Once the target document is identified, amount of time to wait before timing out processing.
- **Audio Feedback** - Turn on or off audio feedback on successful parse.
- **Haptic Feedback** - Turn on or off haptic (vibration) feedback on successful parse.
- **LED Feedback** - Turn on or off LED feedback on successful parse.
- **Debug Mode** - If enabled, allows a session to write form capture, region images, region values, and other data to storage. Use only when directed by administrator.
- **Auto Capture** - Set to **On** to automatically capture forms when detected. Set to **Off** to manually capture forms when user taps screen or presses a trigger button.
- **Image Correction** - Turn on when document is crumpled or curved and requires advanced image correction.
- **Capture Sensitivity** - Increase sensitivity for increased document identification accuracy before processing.
- **About** - Displays the SimulScan Engine version number.
- **Quit Scanner** - Exit Advanced Settings screen.

Demo Customization

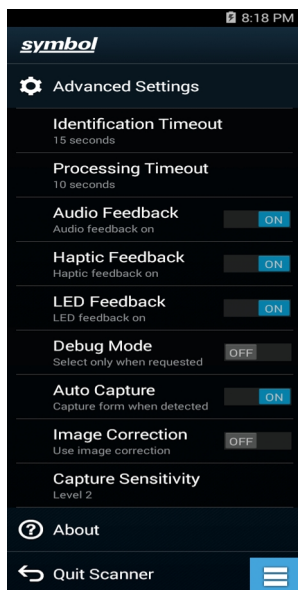
Before creating a customized demo, first:

- Create a template using the Template Builder tool.
- Copy a company logo and image to the device storage location.

Procedure:

- 1 Touch **Menu** icon.
- 2 Touch **Custom Demo Setup**.

Figure 94: Custom Demo Setup Screen

- 3 In the **Name** text box, enter a name for the custom demo. This name appears in the drop-down menu..
- 4 In the **Custom Demo Setup** text box, enter a title for the demo. This appears in the demo screen title box.
- 5 Touch the **Image** field to select an image from the SD card.
- 6 Touch the **Logo** field to select the logo image from the SD card.
- 7 In the **Introduction** text box, enter text that will appear on the demo screen.
- 8 In the **Header color** text box, enter the hex color value for the header.
- 9 In the **Icon color** text box, enter the hex color value for Menu icon and button text.
- 10 In the **Key Features** text box, enter text that will appear under the Key Feature heading. This text appears in bullet format.
- 11 Touch one of the **SimulScan Document Capture Template** fields to select a template
 - a **Browse external storage** - select a template loaded on the device.
 - b **Default templates** - select one of the default templates.
 - c **Select from server** - . select a template from the SimulScan server.
- 12 Touch **Done**. The customized example appears on the screen.
- 13 Touch **Start SimulScan** to begin the demonstration.

Default Templates

The following templates are available:

- **Default - BankCheck.xml** – Use this template to read the MICR E-13B font (length between 19 and 40 characters) on bank checks.
- **Default - Barcode 1.xml** – Use this template to read a single supported bar code.
- **Default - Barcode 10.xml** – Use this template to read up to 10 supported bar codes.
- **Default - Barcode 2.xml** – Use this template to read two supported bar codes.
- **Default - Barcode 4.xml** – Use this template to read up to supported four bar codes.
- **Default - Barcode 5.xml** – Use this template to read up to supported five bar codes.
- **Default - BookNumber.xml** – Use this template to read the OCR-B ISBN 10 or 13 digit book numbers.
- **Default - DocCap + Optional Barcode** – Use this template to capture a full page image and decode any supported bar codes that are in the form. The captured area is the largest rectangular region in the field of view defined by the solid border or contrast of background. Any OCR or OMR content will not be decoded in this mode. The captured area is further processed to correct, de-skew and sharpen and returned as a picture.
- **Default - DocCap + Required Barcode** – Use this template to capture a full page image and decode of any supported bar codes that are present in the form. The captured area is the largest rectangular region in the field of

view defined by the solid border or contrast of background. Any OCR or OMR content will not be decoded in this mode. The captured area is further processed to correct, de-skew and sharpen and returned as a picture.

- **Default - TravelDoc.xml** – Use this template to read passport and Visa travel documents with OCR-B types A and B fonts.
- **Default - Unstructured Multi-Line** – Use this template to read up to seven lines of text.
- **Default - Unstructured Single Line** – Use this template to read a single line of text.

RxLogger

RxLogger is a comprehensive diagnostic tool that provides application and system metrics. It allows for custom plugins to be created and work seamlessly with this tool. RxLogger is used to diagnose device and application issues. Its information tracking includes the following: CPU load, memory load, memory snapshots, battery consumption, power states, wireless logging, cellular logging, TCP dumps, Bluetooth logging, GPS logging, logcat, FTP push/pull, ANR dumps, etc. All logs and files generated are saved onto flash storage on the device (internal or external).

Figure 95: RxLogger

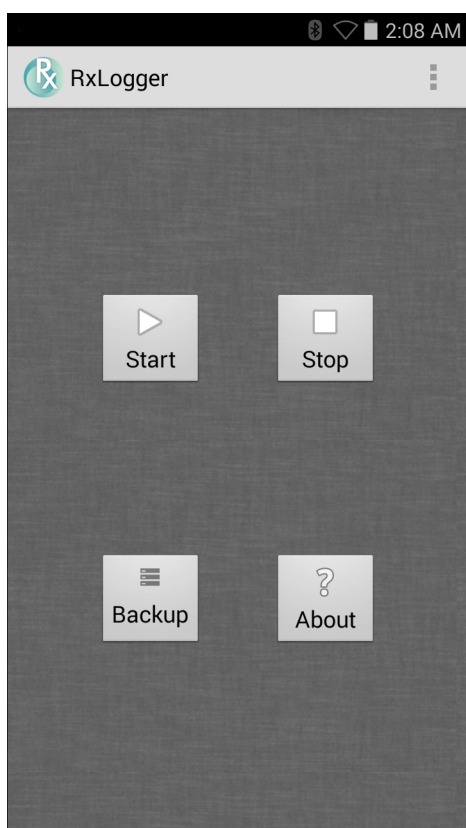

Elemesz



Note:

Elemesz collects specific device information in the background and sends this information to us to help improve product functionality. This feature can be disabled. See [Disabling Elemesz Data Collection on page 106](#).

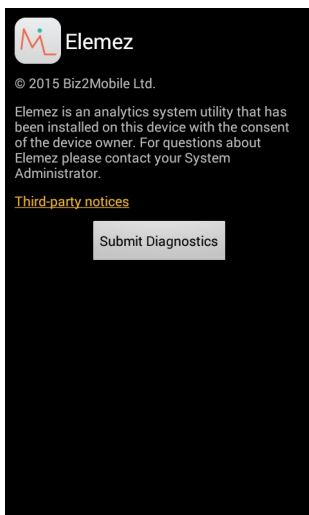

Use **Elemesz** to provide diagnostics information to Zebra. Touch **Submit Diagnostics** button to send the data.

Figure 96: Elemez Application

Disabling Elemez Data Collection

The user can disable the **Elemez** application from collection specific data in the background and sending it to Zebra Technologies.



Procedure:

- 1 From the Home screen, touch .
- 2 Touch **Manage Apps**.
- 3 Swipe left or right until the **ALL** tab displays.
- 4 Scroll through the list and touch **Elemez**.
- 5 In the **App info** screen, touch **Uninstall updates**.
- 6 In the **Uninstall updates** dialog box, touch **OK**.
- 7 Touch **OK**.
- 8 After uninstall is complete, touch **OK**.
- 9 In the **All** tab, scroll through the list and touch **Elemez**.
- 10 Touch **Disable**.
- 11 In the **Disable built-in app?** dialog box, touch **OK**.
- 12 Touch .

Enabling Elemez Data Collection

The user can re-enable the **Elemez** application for collection specific data in the background and sending it to Zebra Technologies.

Procedure:

- 1 From the Home screen, touch .
- 2 Touch **Manage Apps**.
- 3 Swipe left or right until the **ALL** tab displays.
- 4 Scroll through the list and touch **Elemez**.
- 5 In the **App info** screen, touch **Enable**.
- 6 Touch .
- 7 Touch .

8 Touch  or .

9 Touch **Enable Elemez**.

Chapter 5

Data Capture

The TC75 offers data capture using the integrated imager, camera or the RS507 Hands-free imager.

Imaging

The TC75 with an integrated imager has the following features:

- Omnidirectional reading of a variety of bar code symbologies, including the most popular linear, postal, PDF417, and 2D matrix code types.
- The ability to capture and download images to a host for a variety of imaging applications.
- Advanced intuitive laser aiming cross-hair and dot aiming for easy point-and-shoot operation.

The imager uses imaging technology to take a picture of a bar code, stores the resulting image in its memory, and executes state-of-the-art software decoding algorithms to extract the bar code data from the image.

Operational Modes

The TC75 with an integrated imager supports two modes of operation, listed below. Activate each mode by pressing the Scan button.

- **Decode Mode:** In this mode, the TC75 attempts to locate and decode enabled bar codes within its field of view. The imager remains in this mode as long as the user holds the scan button, or until it decodes a bar code.



Note: To enable Pick List Mode, configure in DataWedge or set in an application using a API command.

- **Pick List Mode:** This mode allows the user to selectively decode a bar code when more than one bar code is in the TC75 's field of view. To accomplish this, move the aiming crosshair or dot over the required bar code to decode only this bar code. This feature is ideal for pick lists containing multiple bar codes and manufacturing or transport labels containing more than one bar code type (either 1D or 2D).

Digital Camera

The device with an integrated camera based bar code scanning solution has the following features:

- Omnidirectional reading of a variety of bar code symbologies, including the most popular linear, postal, QR, PDF417, and 2D matrix code types.
- Cross-hair reticle for easy point-and-shoot operation.
- Picklist mode to decode a particular bar code from many in the field of view.

The solution uses the advanced camera technology to take a digital picture of a bar code, and executes state-of-the-art software decoding algorithms to extract the data from the image.

RS507 Hands-Free Imager

The RS507 Hands-free Imager is a wearable bar code scan solution for both 1D and 2D bar code symbologies. The scanner supports Bluetooth Human Interface Device (HID) connection to the device.

Figure 97: RS507 Hands-Free Imager

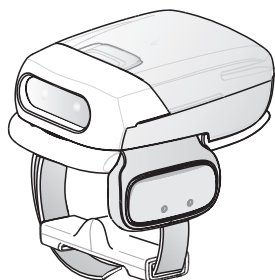

See to the *RS507 Hands-free Imager Product Reference Guide* for more information.

Scanning Considerations

Typically, scanning is a simple matter of aim, scan, and decode and a few quick trial efforts master it. However, consider the following to optimize scanning performance:

- *Range:* Any scanning device decodes well over a particular working range — minimum and maximum distances from the bar code. This range varies according to bar code density and scanning device optics. Scanning within range brings quick and constant decodes; scanning too close or too far away prevents decodes. Move the scanner closer and further away to find the right working range for the bar codes being scanned.
- *Angle:* Scanning angle is important for promoting quick decodes. When laser beams reflect directly back into the scanner from the bar code, this specular reflection can “blind” the scanner. To avoid this, scan the bar code so that the beam does not bounce directly back. But don’t scan at too sharp an angle; the scanner needs to collect scattered reflections from the scan to make a successful decode. Practice quickly shows what tolerances to work within.
- Hold the TC75 farther away for larger symbols
- Move the TC75 closer for symbols with bars that are close together.



Note: Scanning procedures depend on the application and TC75 configuration. An application may use different scanning procedures from the one listed above.

Imager Scanning

To read a bar code, a scan-enabled application is required. The TC75 contains the DataWedge application that allows the user to enable the imager, decode the bar code data and display the bar code content.

Procedure:

- 1 Ensure that an application is open on the TC75 and a text field is in focus (text cursor in text field).
- 2 Point the exit window on the top of the TC75 at a bar code.

Figure 98: Imager Scanning

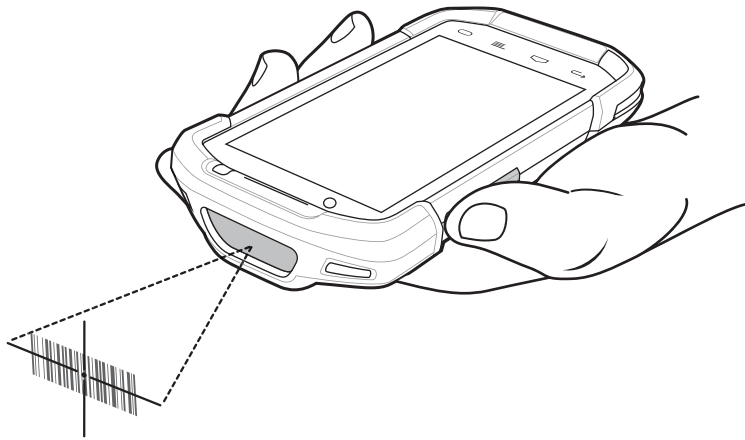

- 3 Press and hold the scan button.
The red laser aiming pattern turns on to assist in aiming.
- 4  **Note:** When the TC75 is in Picklist mode, the imager does not decode the bar code until the crosshair or aiming dot touches the bar code.

Ensure the bar code is within the area formed by the crosshairs in the aiming pattern. The aiming dot is used for increased visibility in bright lighting conditions.

Figure 99: Aiming Pattern

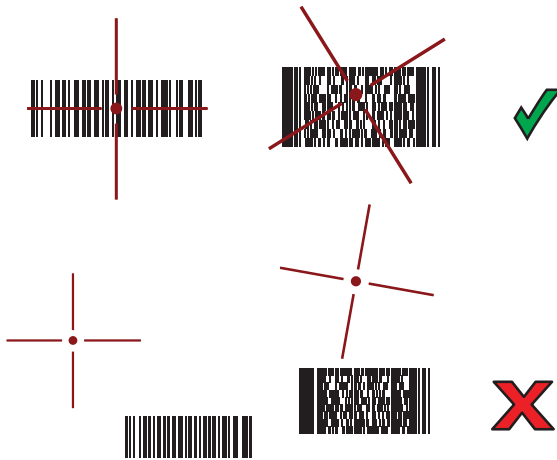

Figure 100: Pick List Mode with Multiple Bar Codes in Aiming Pattern



- 5 The Data Capture LED lights green and a beep sounds, by default, to indicate the bar code was decoded successfully.
- 6 Release the scan button.



Note: Imager decoding usually occurs instantaneously. The TC75 repeats the steps required to take a digital picture (image) of a poor or difficult bar code as long as the scan button remains pressed.

- 7 The bar code content data displays in the text field.

Bar Code Capture with Integrated Camera

To capture bar code data:





Note: When capturing bar code data in poor lighting, turn on **Illumination mode** in the **DataWedge** application. See the *TC75 Integrator Guide* for detailed information on configuring **DataWedge**.

Procedure:

- 1 Ensure that an application is open on the device and a text field is in focus (text cursor in text field).
- 2 Aim the camera at a bar code.
- 3 Press and hold the Scan button. By default, a preview window appears on the screen. The Decode light emitting diode (LED) lights red to indicate that data capture is in process.

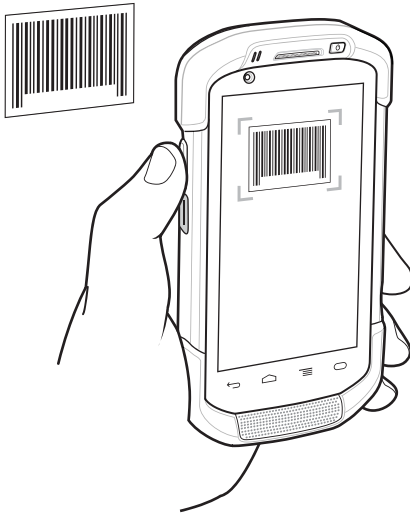
Figure 101: Application with Preview Window



- 4  **Note:** When Picklist mode is enabled, move the TC75 until the bar code is centered under the red target on the screen.

Move the TC75 until the bar code is visible on the screen.

- 5 The Decode LED lights green, a beep sounds and the device vibrates, by default, to indicate the bar code was decoded successfully.
- 6 The captured data appears in the text field.

Bar Code Capture with RS507 Hands-Free Imager

Prerequisites: Pair the RS507 with the TC75. See *Pairing the RS507 Hands-Free Imager Using SSI* or *Pairing the RS507 Hands-Free Imager Bluetooth HID* on page 114 for more information.

Procedure:

- 1 Ensure that an application is open on the device and a text field is in focus (text cursor in text field).

- 2 Point the RS507 at a bar code.

Figure 102: Bar Code Scanning with RS507

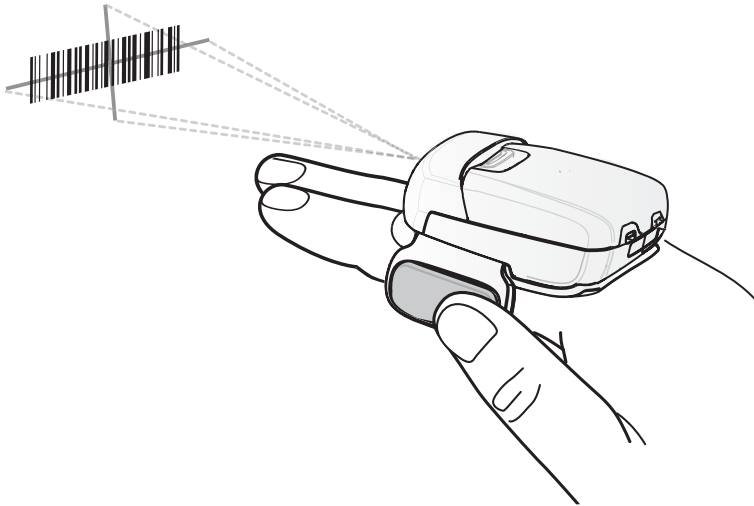

- 3 Press and hold the trigger.

The red laser aiming pattern turns on to assist in aiming. Ensure the bar code is within the area formed by the cross-hairs in the aiming pattern. The aiming dot is used for increased visibility in bright lighting conditions.

The RS507 LEDs light green, a beep sounds to indicate the bar code was decoded successfully. Note that when the RS507 is in Pick List Mode, the RS507 does not decode the bar code until the center of the crosshair touches the bar code.

Figure 103: Aiming Pattern

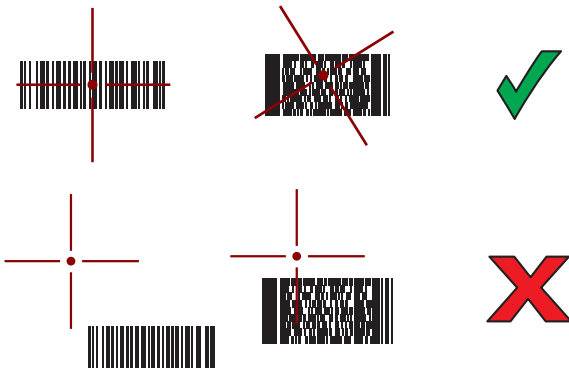

Figure 104: Pick List Mode with Multiple Bar Codes in Aiming Pattern



- 4 The captured data appears in the text field.

Pairing the RS507 Hands-Free Imager Bluetooth HID



An RS507 Hands-free Imager can be used with the device to capture bar code data.

Procedure:

- 1 Ensure that Bluetooth is enabled on both devices.
- 2 Ensure that the Bluetooth device to discover is in discoverable mode.
- 3 Ensure that the two devices are within 10 meters (32.8 feet) of one another.
- 4 Place the RS507 in Human Interface Device (HID) mode. If the RS507 is already in HID mode, skip to step 5.
 - a Remove the battery from the RS507.
 - b Press and hold the Restore key.
 - c Install the battery onto the RS507.
 - d Keep holding the Restore key for about five seconds until a chirp is heard and the Scan LEDs flash green.
 - e Scan the bar code below to place the RS507 in HID mode.

Figure 105: RS507 Bluetooth HID Bar Code



- 5 Remove the battery from the RS507.
- 6 Re-install the battery into the RS507.
- 7 On the , touch .
- 8 Touch .
- 9 Touch  **Bluetooth**.
- 10 Touch **SCAN FOR DEVICES**. The device begins searching for discoverable Bluetooth devices in the area and displays them under **AVAILABLE DEVICES**.
- 11 Scroll through the list and select RS507.
The device connects to the RS507 and **Connected** appears below the device name. The Bluetooth device is added to the **Bluetooth devices** list and a trusted (“paired”) connection is established.



DataWedge

DataWedge is a utility that adds advanced bar code scanning capability to any application without writing code. It runs in the background and handles the interface to built-in bar code scanners. The captured bar code data is converted to keystrokes and sent to the target application as if it was typed on the keypad.

To configure DataWedge refer to the *TC75 Integrator Guide*.

Enabling DataWedge





Procedure:

- 1 Touch .
- 2 Touch .
- 3 Touch .
- 4 Touch **Settings**.

- 5 Touch the **DataWedge enabled** checkbox. A blue checkmark appears in the checkbox indicating that DataWedge is enabled.
- 6 Touch .

Disabling DataWedge

Procedure:

- 1 Touch .
- 2 Touch .
- 3 Touch .
- 4 Touch **Settings**.
- 5 Touch the **DataWedge enabled** checkbox. The blue checkmark disappears from the checkbox indicating that DataWedge is disabled.
- 6 Touch .

Chapter 6

Wireless

This section provides information on the wireless features:

- Wireless Wide Area Network (WWAN)
- Wireless Local Area Network (WLAN)
- Bluetooth
- Near Field Communications (NFC)

Wireless Wide Area Networks

Use Wireless wide area networks (WWANs) to access data over a cellular network. This section provides information on:

- Setting default SIM slot.
- Sharing a data connection
- Disabling data roaming
- Monitoring data usage
- Limiting connections to 2G networks
- Locking a SIM card
- Editing Access Point Names (APNs).

Sharing the Mobile Data Connection

The **tethering & portable hotspot** settings allow you to share your data connection. You can share the TC75's mobile data connection with a single computer via USB tethering or Bluetooth tethering. You can also share the data connection with up to eight devices at once, by turning it into a portable Wi-Fi hotspot. While the TC75 is sharing its data connection, an icon appears at the top of the screen and a corresponding message appears in the notification list.

USB Tethering



Note: USB tethering is not supported on computers running Mac OS. If your computer is running Windows 7 or a recent version of Linux (such as Ubuntu), follow these instructions without any special preparation. If running a version of Windows that precedes Windows 7, or some other operating system, you may need to prepare the computer to establish a network connection via USB.

Procedure:

- 1 Connect the TC75 to a host computer with the USB cable.

A USB icon appears at the top of the screen, and the notification **Connected as a media device** or **Connected as a camera** appears briefly at the top of the screen.

- 2 Touch .

- 3 Touch .

- 4 Touch **More ...** .
- 5 Touch **Tethering & portable hotspot**.
- 6 Check **USB tethering**.
The host computer is now sharing the TC75's data connection.



Postrequisites: To stop sharing the data connection, uncheck **USB tethering** or disconnect the USB cable.

Bluetooth Tethering

Use Bluetooth tethering to share the data connection with a host computer.

Prerequisites: Configure the host computer to obtain its network connection using Bluetooth. For more information, see the host computer's documentation.

Procedure:



- 1 Pair the TC75 with the host computer.
- 2 Touch  .
- 3 Touch  .
- 4 Touch **More ...** .
- 5 Touch **Tethering & portable hotspot**.
- 6 Check **Bluetooth tethering**.
The host computer is now sharing the TC75's data connection.

Postrequisites: To stop sharing the data connection, uncheck **Bluetooth tethering** .

Portable Wi-Fi Hotspot

Prerequisites: Configure the Wi-Fi Hotspot settings.

Procedure:

- 1 Touch  .
- 2 Touch  .
- 3 Touch **More ...** .
- 4 Touch **Tethering & portable hotspot**.
- 5 Check **Portable Wi-Fi hotspot**.
After a moment, the TC75 starts broadcasting its Wi-Fi network name (SSID), so you can connect to it with up to eight computers or other devices.

Postrequisites: To stop sharing the data connection, uncheck **Portable Wi-Fi hotspot**.

Configuring the Wi-Fi Hotspot

Procedure:



- 1 Touch  .
- 2 Touch  .
- 3 Touch **More ...** .
- 4 Touch **Tethering & portable hotspot**.

Figure 106: Set up Wi-Fi Hotspot Dialog Box

- 5 In the **Network SSID** text field, edit the network name.
- 6 Touch the **Country** option and select the country you are in from the drop-down list.
- 7 Touch the **Channel** option and select a channel number from the drop-down list.
- 8 Touch the **Security** option and select a security method from the drop-down list.

- **Open**
- **WPA2 PSK**

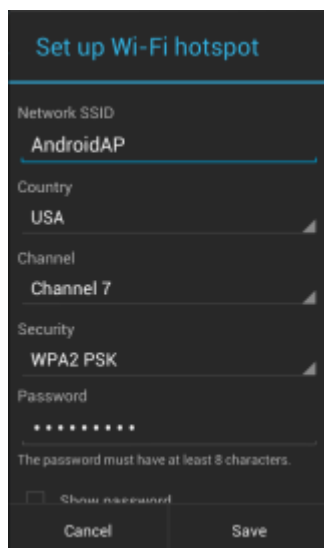

- 9 In the **Password** text field, enter a password.



Note: If **Open** is selected in the **Security** option, a password is not required.

- 10 Touch **Save**.

Data Usage

Data usage refers to the amount of data uploaded or downloaded by the TC75 during a given period. Depending on the wireless plan, you may be charged additional fees when your data usage exceeds your plan's limit. To monitor your data usage, go to  >  **Data usage**.



Caution: The usage displayed on the data usage settings screen is measured by your device. Your carrier's data usage accounting may differ. Usage in excess of your carrier plan's data limits can result in steep overage charges. The feature described here can help you track your usage, but is not guaranteed to prevent additional charges.

Data usage settings allow you to:

- Set the data usage level at which you'll receive a warning.
- Set a data usage limit.
- View or restrict data usage by app.
- Identify mobile hotspots and restrict background downloads that may result in extra charges.

By default, when you open the data usage settings screen you see the settings for mobile data: that is, the data network or networks provided by your carrier:

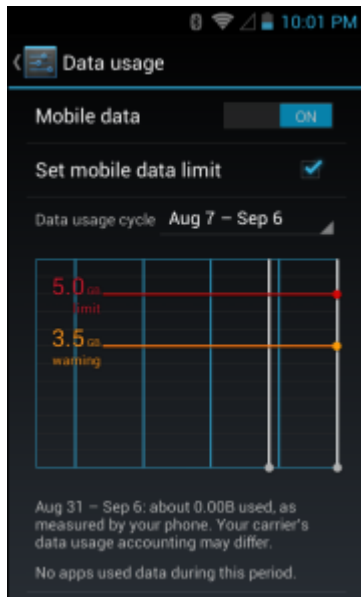
Figure 107: Data Usage Screen

To display Wi-Fi data usage settings in a separate tab touch > **Show Wi-Fi usage**.

Just below the on-off switch, note the data usage cycle. Touch it to choose a different cycle. This date range is the period of time for which the graph displays data usage.

The vertical white lines on the graph show a period of time within the data usage cycle. This range determines the usage amount displayed just below the graph. Drag lines to change the period.

Set Data Usage Warning

Drag the orange line by its right side to the level where you want to receive a warning. When your data usage reaches this level, you'll receive a notification.

Set Auto-Sync

You can also conserve data usage by syncing your apps manually, only when you need the data, rather than relying on auto-sync. To turn auto-sync off or on, touch > **Auto-sync data**.

Disabling Data When Roaming

To prevent the device from transmitting data over other carriers' mobile networks when leaving an area that is covered by the carrier's networks. This is useful for controlling expenses if the service plan does not include data roaming.

Procedure:

- 1 Touch or .
- 2 Touch **More ...**.
- 3 Touch **Mobile networks**.
- 4 Un-check **Data roaming**.

Limiting Data Connection to 2G Networks

Extend the battery life by limiting the data connections to 2G networks (GPRS or EDGE). When connected to a 2G network, the user may want to postpone activities that transmit a lot of data, such as sending, uploading, or downloading pictures or video, until they are connected to a faster mobile or other wireless network.

Procedure:

- 1 Touch .
- 2 Touch **More ...**.
- 3 Touch **Mobile networks**.
- 4 Touch **GSM 2G/3G selection**.
- 5 Touch **2G only**.

Locking the SIM Card

Locking the SIM card requires the user to enter a PIN every time the device is turned on. If the correct PIN is not entered, only Emergency calls can be made.

Procedure:



- 1 Touch .
- 2 Touch .
- 3 Touch  **Security**.
- 4 Touch **Set up SIM/RUIM card lock**.
- 5 Touch **Lock SIM card**.

Figure 108: Enter PIN to Lock SIM Card





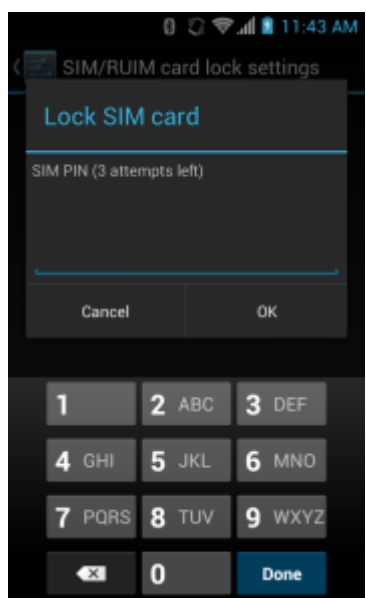

- 6 Enter the PIN associated with the card. Touch **OK**.
- 7 Reset the device.

Editing the Access Point Name

To use the data on a network the user must configure the APN information.

Procedure:

- 1 Touch .
- 2 Touch .
- 3 Touch **More ...**.
- 4 Touch **Mobile networks**.
- 5 Touch **Access Point Names**.
- 6 Touch .
- 7 Touch **New APN**.
- 8 Touch each APN settings and enter the appropriate data obtained from the wireless service provider.
- 9 When finished, touch .
- 10 Touch **Save**.
- 11 Touch the radio button next to the new APN name to start using it.
- 12 Touch .

Wireless Local Area Networks

Wireless local area networks (WLANs) allow the TC75 to communicate wirelessly inside a building. Before using the TC75 on a WLAN, the facility must be set up with the required hardware to run the WLAN (sometimes known as infrastructure). The infrastructure and the TC75 must both be properly configured to enable this communication.

Refer to the documentation provided with the infrastructure (access points (APs), access ports, switches, Radius servers, etc.) for instructions on how to set up the infrastructure.

Once the infrastructure is set up to enforce the chosen WLAN security scheme, use the **Wireless & networks** settings configure the TC75 to match the security scheme.

The TC75 supports the following WLAN security options:

- Open
- Wireless Equivalent Privacy (WEP).
- Wi-Fi Protected Access (WPA)/WPA2 Personal (PSK).
- Extensible Authentication Protocol (EAP).

The **Status** bar displays icons that indicate Wi-Fi network availability and Wi-Fi status. See [Status Bar on page 43](#) for more information.



Note: Turn off Wi-Fi when not using it, to extend the life of the battery.

Scan and Connect to a Wi-Fi Network

Procedure:

- 1 Touch .
- 2 Touch .

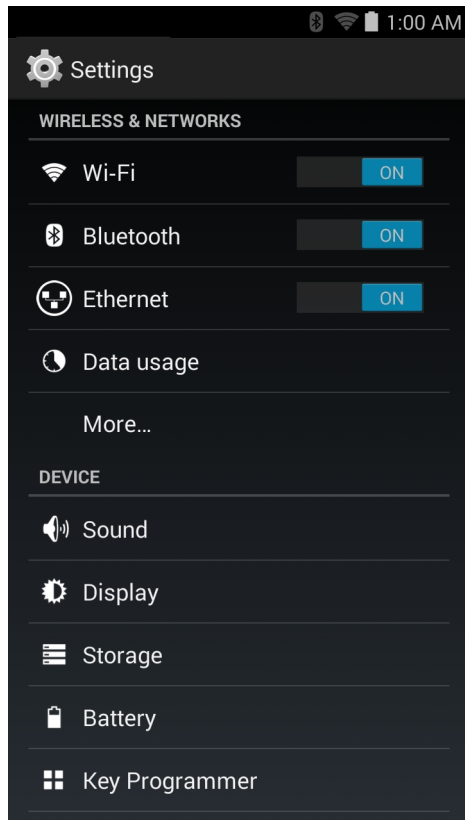
Figure 109: Settings Screen

- 3 Slide the **Wi-Fi** switch to the **ON** position.
- 4 Touch  **Wi-Fi**. The TC75 searches for WLANs in the area and lists them.

Figure 110: Wi-Fi Screen

- 5 Scroll through the list and select the desired WLAN network.
- 6 For open networks, touch profile once or press and hold and then select **Connect to network** or for secure networks enter the required password or other credentials then touch **Connect**. See the system administrator for more information.

The TC75 obtains a network address and other required information from the network using the dynamic host configuration protocol (DHCP) protocol. To configure the TC75 with a fixed internet protocol (IP) address, See [Configuring the Device to Use a Static IP Address on page 127](#).

- 7 In the Wi-Fi setting field, **Connected** appears indicating that the TC75 is connected to the WLAN.

Configuring a Wi-Fi Network

To set up a Wi-Fi network:

Procedure:



- 1 Touch .
- 2 Touch  **Wi-Fi**.
- 3 Slide the switch to the **ON** position.
- 4 The device searches for WLANs in the area and lists them on the screen.
- 5 Scroll through the list and select the desired WLAN network.
- 6 Touch the desired network. If the network security is **Open**, the device automatically connects to the network. For all other network security a dialog box appears.

Figure 111: WLAN Network Security Dialog Box



7 If the network security is **WEP** or **WPA/WPS2 PSK**, enter the required password and then touch **Connect**.

8 If the network security is 802.1x EAP:

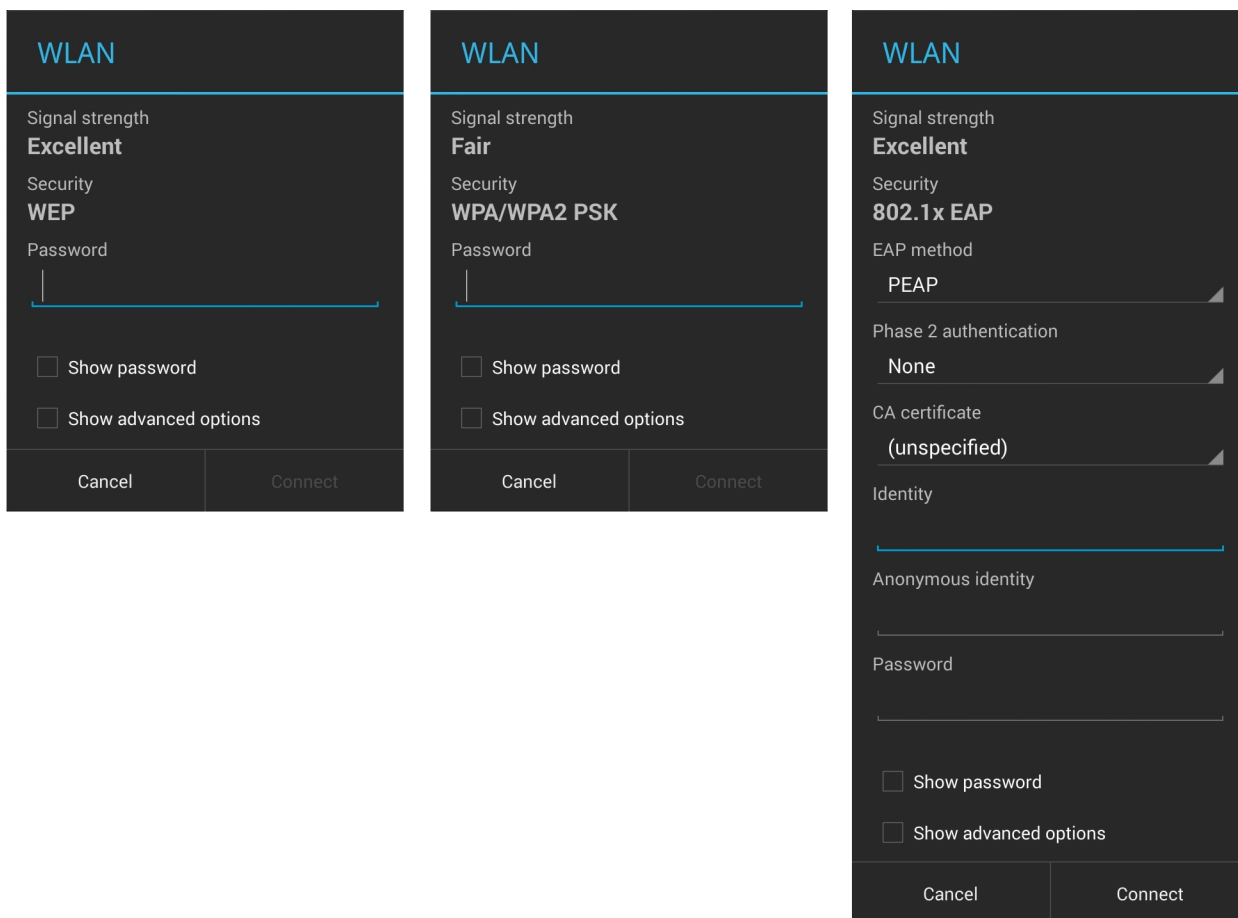
- Touch the **Phase 2 authentication** drop-down list and select an authentication method.
- If required, touch **CA certificate** and select a Certification Authority (CA) certificate. Note: Certificates are installed using the **Security** settings.
- If required, touch **User certificate** and select a user certificate. Note: User certificates are installed using the Location & security settings.
- If required, in the **Identity** text box, enter the username credentials.
- If desired, in the **Anonymous identity** text box, enter an anonymous identity username.
- If required, in the **Password** text box, enter the password for then given identity.

9  **Note:** By default, the network Proxy is set to **None** and the IP settings is set to **DHCP**. See [Configuring for a Proxy Server on page 126](#) for setting connection to a proxy server and see [Configuring the Device to Use a Static IP Address on page 127](#) for setting the device to use a static IP address.



Touch **Connect**.

10 Touch .

Manually Adding a Wi-Fi Network

Manually add a Wi-Fi network if the network does not broadcast its name (SSID) or to add a Wi-Fi network when out of range.

Procedure:

- 1 Touch .
- 2 Touch  **Wi-Fi**.
- 3 Slide the Wi-Fi switch to the **On** position.
- 4 Touch + at the bottom of the screen.
- 5 In the **Network SSID** text box, enter the name of the Wi-Fi network.
- 6 In the **Security** drop-down list, select the type of security. Options:
 - **None**
 - **WEP**
 - **WPA/WPA2 PSK**
 - **802.1x EAP**.
- 7 If the network security is **None**, touch **Save**.
- 8 If the network security is **WEP** or **WPA/WPA2 PSK**, enter the required password and then touch **Save**.
- 9 If the network security is **802.1x EAP**:
 - Touch the **Phase 2 authentication** drop-down list and select an authentication method.
 - If required, touch **CA certificate** and select a Certification Authority (CA) certificate. Note: Certificates are installed using the **Security** settings.
 - If required, touch **User certificate** and select a user certificate. Note: User certificates are installed using the **Security** settings.
 - If required, in the **Identity** text box, enter the username credentials.
 - If desired, in the **Anonymous** identity text box, enter an anonymous identity username.
 - If required, in the **Password** text box, enter the password for then given identity.
- 10  **Note:** By default, the network Proxy is set to **None** and the IP settings is set to **DHCP**. See [Configuring for a Proxy Server on page 126](#) for setting connection to a proxy server and see [Configuring the Device to Use a Static IP Address on page 127](#) for setting the device to use a static IP address.

Touch **Save**. To connect to the saved network, touch and hold on the saved network and select **Connect to network**.

Configuring for a Proxy Server

A proxy server is a server that acts as an intermediary for requests from clients seeking resources from other servers. A client connects to the proxy server, requesting some service, such as a file, connection, web page, or other resource, available from a different server. The proxy server evaluates the request according to its filtering rules. For example, it may filter traffic by IP address or protocol. If the request is validated by the filter, the proxy provides the resource by connecting to the relevant server and requesting the service on behalf of the client.

It is important for enterprise customers to be able to set up secure computing environments within their companies, and proxy configuration is an essential part of doing that. Proxy configuration acts as a security barrier ensuring that the proxy server monitors all traffic between the Internet and the intranet. This is normally an integral part of security enforcement in corporate firewalls within intranets.

Procedure:

- 1 In the network dialog box, touch a network.
- 2 Touch **Show advanced options** checkbox.
- 3 Touch **Proxy settings** and select **Manual**.

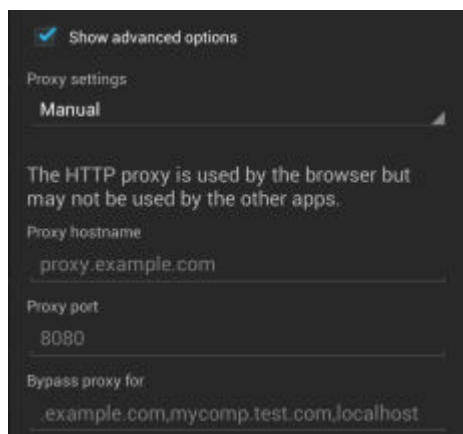
Figure 112: Proxy Settings

4 In the **Proxy hostname** text box, enter the address of the proxy server.

5 In the **Proxy port** text box, enter the port number for the proxy server.



Note: When entering proxy addresses the **Bypass proxy for** field, do not use spaces or carriage returns between addresses.

6 In the **Bypass proxy for** text box, enter addresses for web sites that do not require to go through the proxy server. Use a comma “,” between addresses.

7 Touch **Connect**.

8 Touch .

Configuring the Device to Use a Static IP Address

By default, the device is configured to use Dynamic Host Configuration Protocol (DHCP) to assign an Internet protocol (IP) address when connecting to a wireless network. To configure the device to connect to a network using a static IP address:

Procedure:

1 In the network dialog box, touch a network.

2 Touch **Show advanced options** checkbox.

3 Touch **IP settings** and select **Static**.

Figure 113: Static IP Settings

4 In the **IP address** text box, enter an IP address for the device.

5 If required, in the **Gateway** text box, enter a gateway address for the device.

- 6 If required, in the **Network prefix length** text box, enter a the prefix length.
- 7 If required, in the **DNS 1** text box, enter a Domain Name System (DNS) address.
- 8 If required, in the **DNS 2** text box, enter a DNS address.
- 9 Touch **Connect**.
- 10 Touch .

Advanced Wi-Fi Settings



Note: Advanced Wi-Fi settings are for the device not for a specific wireless network.

Use the **Advanced** settings to configure additional Wi-Fi settings. From the **Wi-Fi** screen, touch  > **Advanced** to view the advanced settings.

- **General**
 - **Network notification** - When enabled, notifies the user when an open network is available.
 - **Keep Wi-Fi on during sleep** - Opens a menu to set whether and when the Wi-Fi radio turns off.
 - + **Always On** - The radio stays on when the device enters suspend mode.
 - + **Only when plugged in** - The radio stays on while the device is connected to external power.
 - + **Never On** - The radio turns off when the device enters suspend mode (default).
 - **Install Certificates** – Touch to install certificates.
 - **Wi-Fi optimization** – Touch to minimize battery usage when Wi-Fi is on (default – disabled)
 - **MAC address** - Displays the Media Access Control (MAC) address of the device when connecting to Wi-Fi networks.
- **Regulatory**
 - **Country selection** - Displays the acquired country code if 802.11d is enabled else it displays the currently selected country code.
 - **Region code** - Displays the current region code.
- **Band and Channel Selection**
 - **Wi-Fi frequency band** - Use to select the frequency band. Options: **Auto** (default), **5 GHz only** or **2.4 GHz only**.
 - **Available channels (2.4 GHz)** - Use to select specific channels. Touch to display the **Available channels** menu. Select specific channels. Touch **OK**.
 - **Available channels (5 GHz)** - Use to select specific channels. Touch to display the **Available channels** menu. Select specific channels. Touch **OK**.
- **Logging**
 - **Advanced Logging** – Touch to enable advanced logging. Advanced logging
 - **Wireless logs** - Use to capture Wi-Fi log files.
 - + **Fusion Logger** - Touch to open the **Fusion Logger** application. This application maintains a history of high level WLAN events which helps to understand the status of connectivity.

Figure 114: Fusion Logger Screen

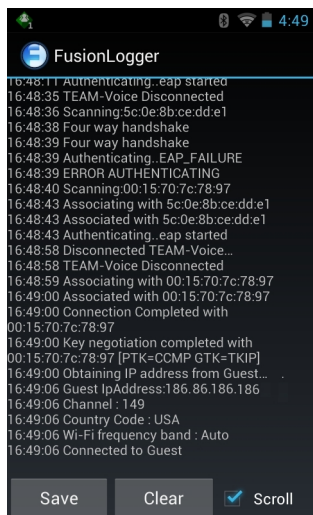

- + **Fusion Status** - Touch to display live status of WLAN state. Also provides information of device and connected profile.

Figure 115: Fusion Status Screen

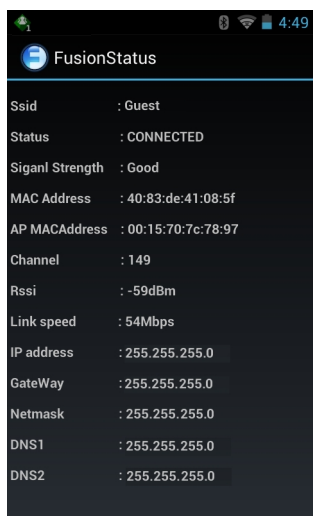





- **About**
 - **Version** - Displays the current Fusion information.

Remove a Wi-Fi Network

To remove a remembered or connected network:

Procedure:

- 1 Touch .
- 2 Touch .
- 3 Touch  **Wi-Fi**.
- 4 In the **Wi-Fi networks** list, touch and hold the name of the network.
- 5 In the menu, touch **Forget network**.

6 Touch 

Bluetooth

Bluetooth-equipped devices can communicate without wires, using frequency-hopping spread spectrum (FHSS) radio frequency (RF) to transmit and receive data in the 2.4 GHz Industry Scientific and Medical (ISM) band (802.15.1). Bluetooth wireless technology is specifically designed for short-range (10 meters (32.8 feet)) communication and low power consumption.

Devices with Bluetooth capabilities can exchange information (e.g., files, appointments, and tasks) with other Bluetooth enabled devices such as printers, access points, and other mobile devices.

The TC75 support Bluetooth Low Energy. Bluetooth Low Energy is targeted at applications in the healthcare, fitness, security, and home entertainment industries. It provides reduced power consumption and cost while maintaining standard Bluetooth range.

Adaptive Frequency Hopping

Adaptive Frequency Hopping (AFH) is a method of avoiding fixed frequency interferers, and can be used with Bluetooth voice. All devices in the piconet (Bluetooth network) must be AFH-capable in order for AFH to work. There is no AFH when connecting and discovering devices. Avoid making Bluetooth connections and discoveries during critical 802.11b communications. AFH for Bluetooth consists of four main sections:

- Channel Classification - A method of detecting an interference on a channel-by-channel basis, or pre-defined channel mask.
- Link Management - Coordinates and distributes the AFH information to the rest of the Bluetooth network.
- Hop Sequence Modification - Avoids interference by selectively reducing the number of hopping channels.
- Channel Maintenance - A method for periodically re-evaluating the channels.

When AFH is enabled, the Bluetooth radio “hops around” (instead of through) the 802.11b high-rate channels. AFH coexistence allows Enterprise devices to operate in any infrastructure.

The Bluetooth radio in this device operates as a Class 2 device power class. The maximum output power is 2.5 mW and the expected range is 10 meters (32.8 ft.). A definition of ranges based on power class is difficult to obtain due to power and device differences, and whether one measures open space or closed office space.



Note: It is not recommended to perform Bluetooth wireless technology inquiry when high rate 802.11b operation is required.

Security

The current Bluetooth specification defines security at the link level. Application-level security is not specified. This allows application developers to define security mechanisms tailored to their specific need. Link-level security occurs between devices, not users, while application-level security can be implemented on a per-user basis. The Bluetooth specification defines security algorithms and procedures required to authenticate devices, and if needed, encrypt the data flowing on the link between the devices. Device authentication is a mandatory feature of Bluetooth while link encryption is optional.

Pairing of Bluetooth devices is accomplished by creating an initialization key used to authenticate the devices and create a link key for them. Entering a common personal identification number (PIN) in the devices being paired generates the initialization key. The PIN is never sent over the air. By default, the Bluetooth stack responds with no key when a key is requested (it is up to user to respond to the key request event). Authentication of Bluetooth devices is based-upon a challenge-response transaction. Bluetooth allows for a PIN or passkey used to create other 128-bit keys used for security and encryption. The encryption key is derived from the link key used to authenticate the pairing devices. Also worthy of note is the limited range and fast frequency hopping of the Bluetooth radios that makes long-distance eavesdropping difficult.

Recommendations are:

- Perform pairing in a secure environment
- Keep PIN codes private and do not store the PIN codes in the device
- Implement application-level security.

Bluetooth Profiles

The device supports the following Bluetooth services:

- Service Discovery Protocol (SDP) - Handles the search for known and specific services as well as general services.
- Serial Port Profile (SPP) - Allows use of RFCOMM protocol to emulate serial cable connection between two Bluetooth peer devices. For example, connecting the device to a printer.
- Object Push Profile (OPP) - Allows the device to push and pull objects to and from a push server.
- Advanced Audio Distribution Profile (A2DP) - Allows the device to stream stereo-quality audio to a wireless headset or wireless stereo speakers.
- Audio/Video Remote Control Profile (AVRCP) - Allows the device to control A/V equipment to which a user has access. It may be used in concert with A2DP.
- Personal Area Network (PAN) - Allows the use of Bluetooth Network Encapsulation Protocol to provide L3 networking capabilities over a Bluetooth link. Only PANU role is supported.
- Human Interface Device Profile (HID) - Allows Bluetooth keyboards, pointing devices, gaming devices and remote monitoring devices to connect to the device.
- Headset Profile (HSP) - Allows a hands-free device, such as a Bluetooth headset, to place and receive calls on the device.
- Hands-Free Profile (HFP) - Allows car hands-free kits to communicate with the device in the car.
- Dial-up Networking (DUN) - Allows the device to access the Internet and other dial-up services using a Bluetooth enabled mobile phone.
- Out of Band (OOB) - Allows exchange of information used in the pairing process. Pairing is completed using the Bluetooth radio, but requires information from the OOB mechanism. Using OOB with NFC enables pairing when devices simply get close, rather than requiring a lengthy discovery process.

Bluetooth Power States

The Bluetooth radio is off by default.

- **Suspend** - When the TC75 goes into suspend mode, the Bluetooth radio stays on.
- **Airplane Mode** - When the TC75 is placed in Airplane Mode, the Bluetooth radio turns off. When Airplane mode is disabled, the Bluetooth radio returns to the prior state. When in Airplane Mode, the Bluetooth radio can be turned back on if desired.

Bluetooth Radio Power

Turn off the Bluetooth radio to save power or if entering an area with radio restrictions (e.g., an airplane). When the radio is off, other Bluetooth devices cannot see or connect to the device. Turn on the Bluetooth radio to exchange information with other Bluetooth devices (within range). Communicate only with Bluetooth radios in close proximity.





Note: To achieve the best battery life turn off radios when not in use.

Enabling Bluetooth



Procedure:

- 1 Touch .

- 2 Touch .
- 3 Slide the Bluetooth switch to the **ON** position.  also appears in the Status bar.
- 4 Touch .

Disabling Bluetooth

Procedure:

- 1 Touch .
- 2 Touch .
- 3 Slide the Bluetooth switch to the **OFF** position.
- 4 Touch .

Discovering Bluetooth Device(s)

The TC75 can receive information from discovered devices without pairing. However, once paired, the TC75 and a paired device exchange information automatically when the Bluetooth radio is on. To find Bluetooth devices in the area:

Procedure:



- 1 Ensure that Bluetooth is enabled on both devices.
- 2 Ensure that the Bluetooth device to discover is in discoverable mode.
- 3 Ensure that the two devices are within 10 meters (32.8 feet) of one another.
- 4 Touch .
- 5 Touch .
- 6 Touch  **Bluetooth**.
- 7 Touch **SCAN FOR DEVICES**. The TC75 begins searching for discoverable Bluetooth devices in the area and displays them under **AVAILABLE DEVICES**.
- 8 Scroll through the list and select a device. The **Bluetooth pairing request** dialog box appears.

Figure 116: Bluetooth Pairing - Enter PIN

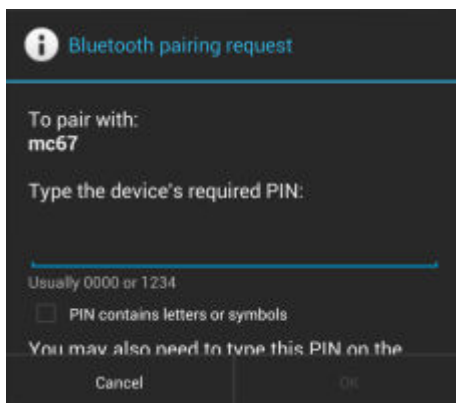
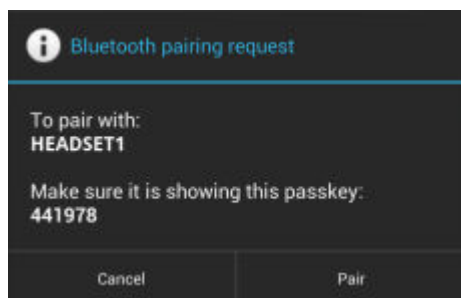







Figure 117: Bluetooth Pairing - Smart Pairing

- 9 Enter a PIN in the text box and touch **OK**. Enter the same PIN on the other device.
- 10 For Simple Pairing, touch **Pair** on both devices.
- 11 The Bluetooth device is added to the **Bluetooth devices** list and a trusted (“paired”) connection is established.

Changing the Bluetooth Name

By default, the TC75 has a generic Bluetooth name that is visible to other devices when connected.



Procedure:

- 1 Touch .
- 2 Touch .
- 3 Touch  **Bluetooth**.
- 4 If Bluetooth is not on, slide the switch to the **ON** position.
- 5 Touch .
- 6 Touch **Rename device**.
- 7 Enter a name and touch **Done**.
- 8 Touch .

Connecting to a Bluetooth Device

Once paired, connect to a Bluetooth device.

Procedure:





- 1 Touch .
- 2 Touch .
- 3 Touch  **Bluetooth**.
- 4 If Bluetooth is not on, slide the switch to the **ON** position.
- 5 In the **PAIRED DEVICES** list, touch and hold on a unconnected Bluetooth device until a menu appears.
- 6 Touch **Connect**. When connected, the device is displayed as connected in the list.

Selecting Profiles on the Bluetooth Device

Some Bluetooth devices have multiple profiles. To select a profile:

Procedure:





- 1 Touch .

- 2 Touch .
- 3 Touch  **Bluetooth**.
- 4 In the **PAIRED DEVICES** list, touch  next to the device name.
- 5 Under **PROFILES**, check or uncheck a profile to allow the device to use that profile.
- 6 Touch .

Unpairing a Bluetooth Device

To unpair a Bluetooth device and erase all pairing information:

Procedure:

- 1 Touch .
- 2 Touch .
- 3 Touch  **Bluetooth**.
- 4 In the **PAIRED DEVICES** list, touch  next to the device name.
- 5 Touch **Unpair**.
- 6 Touch .

Near Field Communications

NFC/HF RFID is a short-range wireless connectivity technology standard that enables secure transaction between a reader and a contactless smartcard. The technology is based on ISO/IEC 14443 type A and B (proximity) and ISO/IEC 15693 (vicinity) standards, using the HF 13.56 MHz unlicensed band. The TC75 support 3 operating modes:

- Reader mode
- Peer-to-Peer communication
- Card Emulation mode.

Using NFC, the TC75 can:

- Read contactless cards such as contactless tickets, ID cards and ePassport.
- Read and write information to contactless cards such as SmartPosters and tickets, as well as devices with NFC interface such as vending machines.
- Read information from supported medical sensors.
- Pair with supported Bluetooth devices such as printers and headsets.
- Exchange data with another NFC device.
- Emulate contactless card such as payment, ticket or SmartPoster.

The TC75 NFC antenna is uniquely positioned to read NFC cards from the top of the device while being held in the user's hand.

Reading NFC Cards

Procedure:

- 1 Launch an NFC enabled application.
- 2 Hold device as shown.

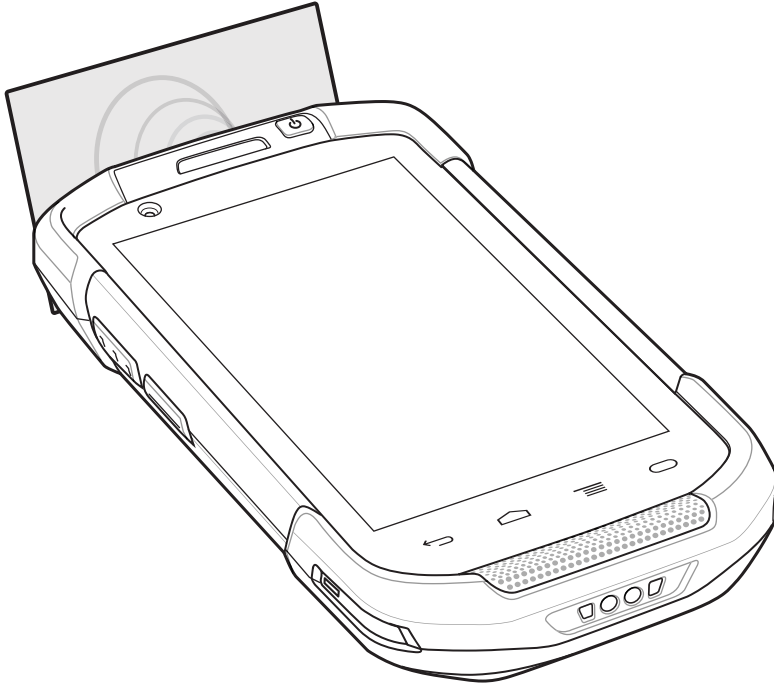
Figure 118: Reading Cards

- 3 Move TC75 close to the NFC card until the TC75 detects the card.
- 4 Hold the card steadily until the transaction is complete (usually indicated by the application).

Sharing Information Using NFC

You can beam content like a web page, contact cards, pictures, YouTube links or location information from your screen to another device by bringing the devices together back to back.

Prerequisites: Make sure both devices are unlocked, support NFC, and have both NFC and Android Beam turned on.

Procedure:

- 1 Open a screen that contains a web page, video, photo or contact.
- 2 Move the top of the TC75 toward the top of the other device.

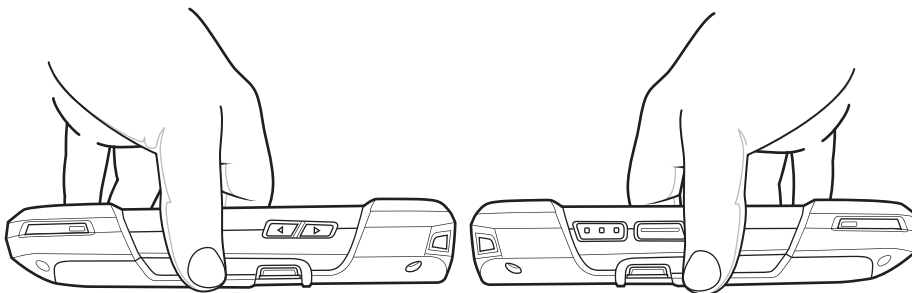
Figure 119: Sharing Data Using NFC

When the devices connect, you hear a sound, the image on the screen reduces in size, the message **Touch to beam** appears.

- 3 Touch anywhere on the screen.
The transfer begins.

Enterprise NFC Settings

The Enterprise NFC Settings provides advanced configuration of the NFC radio.

To configure the NFC settings, touch **Settings** > **More ...** > **Enterprise NFC Settings**.

Figure 120: Wireless & Networks Screen

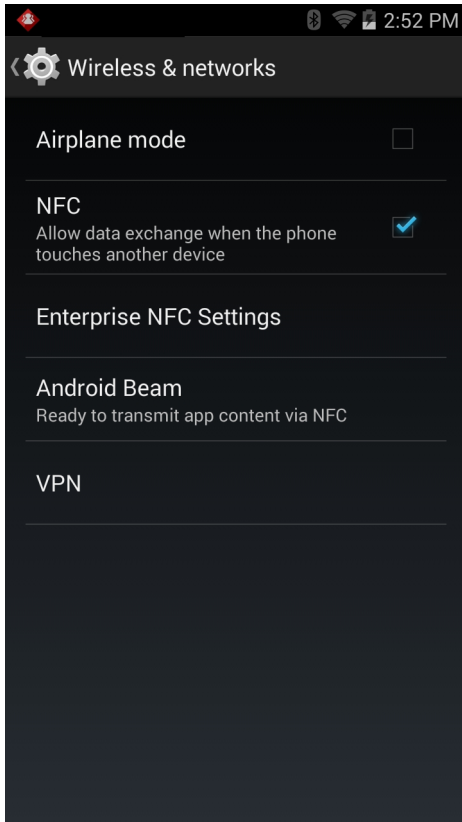
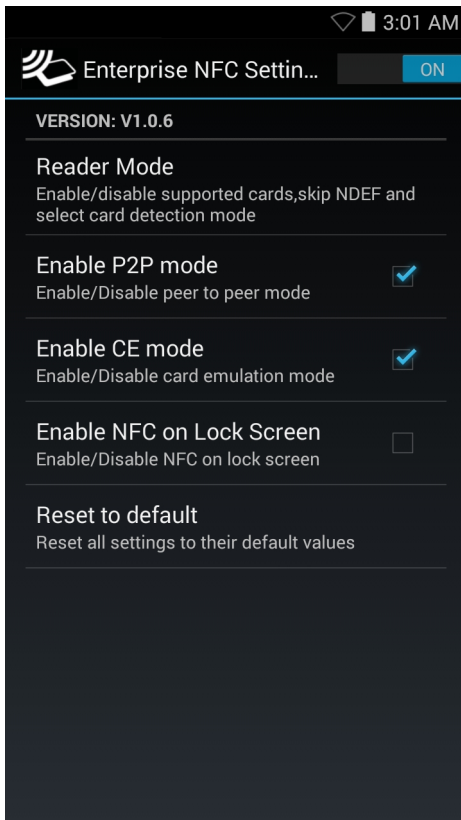

Figure 121: Enterprise NFC Settings Screen



- **Reader Mode** – Touch to open the Reader Mode setting screen.
- **Enable P2P mode** – Enable or disable peer to peer mode. Default: Enabled.
- **Card Emulation Mode** – Enable or disable card emulation mode. Default: Disabled.
- **Enable CE mode** – Touch to enable or disable card emulation mode. Default: Enabled.
- **Enable NFC on Lock Screen** – Enable or disable NFC on lock screen.
- **Reset to Default** – Reset all NFC settings to factory default settings.

Reader Mode

Use the **Reader Mode** settings to configure the NFC radio.

Figure 122: Reader Mode Settings

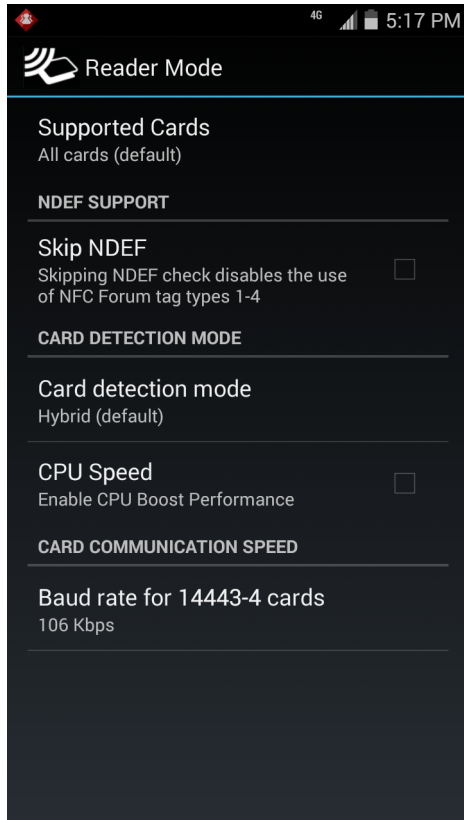

- **Supported Cards** – Touch to select the type of NFC cards to support. Options: **All Cards** (default), **Type A**, **Type B**, **Type F** or **Type V**.
- **NDEF Support**
 - **Skip NDEF** – Enables or disables the use of NFC Forum tag types 1 through 4. Default: Disabled.
- **Card Detection Mode**
 - **Card detection mode** – Touch to select the card detection mode. Options: **Low power**, **Standard** or **Hybrid** (default).
 - **CPU Speed** – Touch to enhance NFC transaction performance while reading small amounts data. Default: Enabled.
- **Card Communication Speed**
 - **Baud rate for 14443–4 cards** - Options: **106 kbps** (default), **212 kbps**, **424 kbps** or **848 kbps** .

Chapter 7

Accessories

This chapter provides information for using the accessories for the device.

Accessories

This table lists the accessories available for the TC75.

Table 12: TC75 Accessories

Accessory	Part Number	Description
Cradles		
2-Slot Charge Only Cradle	CRD-TC7X-SEC2U1-01	Provides device and spare battery charging. Use with power supply, p/n PWRS-14000-148R.
2-Slot USB/Ethernet Cradle	CRD-TC7X-SE2EU1-01	Provides device and spare battery charging and USB communication with a host computer and Ethernet communication with a network. Use with power supply, p/n PWRS-14000-148R.
5-Slot Charge Only Cradle	CRD-TC7X-SE5C1-01	Charges up to five devices. Use with power supply, p/n PWRS-14000-241R and DC line cord, p/n 50-16002-029R. Can accommodate one 4-Slot Battery Charger using the Battery Adapter Cup.
5-Slot Ethernet Cradle	CRD-TC7X-SE5EU1-01	Provides device charging and provides Ethernet communication for up to five devices. Use with power supply, p/n PWRS-14000-241R and DC line cord, p/n 50-16002-029R. Can accommodate one 4-Slot Battery Charger using the Battery Adapter Cup.
Cradle Mount	KT-UNIVLBRKT-01R	Mounts the 5-Slot Charge Only Cradle, 5-Slot Ethernet Cradle, and 4-Slot Battery Charger to a wall or rack.
Batteries and Chargers		
4,620 mAh PowerPrecision battery	BTRY-TC7X-46MA2-01	Replacement battery (single pack).
	BTRY-TC7X-46MA2-10	Replacement battery (10-pack).
4-Slot Spare Battery Charger	SAC-TC7X-4BTYC1-01	Charges up to four battery packs. Use with power supply, p/n PWRS-14000-148R.
Battery Charger Adapter Cup	CUP-SE-BTYADP1-01	Allows for one 4-Slot Battery Charger to be charged and docked on the left most slot of the 5-Slot cradles (maximum one per cradle).

Table continued...

Accessory	Part Number	Description
Payment		
Magnetic Stripe Reader	MSR-TC7X-SNP1-01	Captures data from magnetic stripe cards.
Vehicle Solutions		
Charging Cable Cup	CHG-TC7X-CLA1-01	Provides power to the device from a cigarette lighter socket.
Charge Only Vehicle Cradle	CRD-TC7X-CVCD1-01	Charges and securely holds the device. Requires power cable CHG-AUTO-CLA1-01 or CHG-AUTO-HWIRE1-01, sold separately.
Cigarette Light Adapter Auto Charge Cable	CHG-AUTO-CLA1-01	Provides power to the Vehicle Cradle from a cigarette lighter socket.
Hard-wire Auto Charge Cable	CHG-AUTO-HWIRE1-01	Provides power to the Vehicle Cradle from the vehicle's power panel.
RAM Mount	RAM-B-166U	Provides window mounting option for the Vehicle Cradle. RAM Twist Lock Suction Cup with Double Socket Arm and Diamond Base Adapter. Overall Length: 6.75".
RAM Mount Base	RAM-B-238U	RAM 2.43" x 1.31" Diamond Ball base with 1" ball.
Charge and Communication Cables		
Charging Cable Cup	CHG-TC7X-CBL1-01	Provides power to the device. Use with power supply, p/n PWRS-14000-249R, sold separately.
Snap-On USB Cable	CBL-TC7X-CBL1-01	Provides power to the device and USB communication with a host computer. Use with power supply, p/n PWRS-14000-249R, sold separately.
Snap-On Serial Cable	CBL-TC7X-SERL1-01	Provides power and serial communication with a host computer. Use with power supply, p/n PWRS-14000-249R, sold separately.
Snap-On DEX Cable	CBL-TC7X-DEX1-01	Provides electronic data exchange with devices such as vending machines.
Audio Accessories		
2.5 mm Audio Adapter	ADP-TC7X-AUDIO1-01	Snaps onto the device and provides audio to a wired headset with 2.5 mm plug.
2.5 mm Headset	HDST-25MM-PTVP-01	Use for PTT and VoIP calls
Premium Headset	RCH51	Premium Rugged headset.
2.5 mm Quick Disconnect Adapter Cable	25-124387-02R	Provides connection to the RCH50/RCH51 headset.
3.5 mm Audio Adapter	ADP-TC7X-AUD35-01	Snaps onto the device and provides audio to a wired headset with 3.5 mm plug.
3.5 mm Headset	HDST-35MM-PTVP-01	Use for PTT and VoIP calls.
3.5 mm Quick Disconnect Adapter Cable	ADP-35M-QDCBL1-01	Provides connection to the 3.5 mm Headset.
Scanning		

Table continued...

Accessory	Part Number	Description
Trigger Handle	TRG-TC7X-SNP1-01	Adds gun-style handle with a scanner trigger for comfortable and productive scanning.
Carrying Solutions		
Soft Holster	SG-TC7X-HLSTR1-01	TC7X soft holster.
Rigid Holster	SG-TC7X-RHLSTR1-01	TC7X rigid holster.
Hand Strap	SG-TC7X-HSTRP1-03	Replacement hand strap with hand strap mounting clip (3-pack).
Stylus and Coiled Tether	SG-TC7X-STYLUS-03	TC7X stylus with coiled tether (3-pack).
Power Supplies		
Power Supply	PWRS-14000-249R	Provides power to the device using the Snap-On USB Cable, Snap-on Serial Cable or Charging Cable Cup. Requires AC line cord.
Power Supply	PWRS-14000-148R	Provides power to the 2-Slot cradles and 4-Slot Spare Battery Charger. Requires AC line cord.
Power Supply	PWRS-14000-241R	Provides power to the 5-Slot Charge Only cradle and the 5-Slot Ethernet Cradle. Requires DC Line Cord, p/n 50-16002-029R and country specific three wire grounded AC line cord sold separately.
DC Line Cord	50-16002-029R	Provides power from the power supply to the 5-Slot Charge Only Cradle and 5-Slot Ethernet Cradle.

2-Slot Charge Only Cradle

The 2-Slot Charge Only Cradle:

- Provides 5 VDC power for operating the device.
- Charges the device's battery.
- Charges a spare battery.

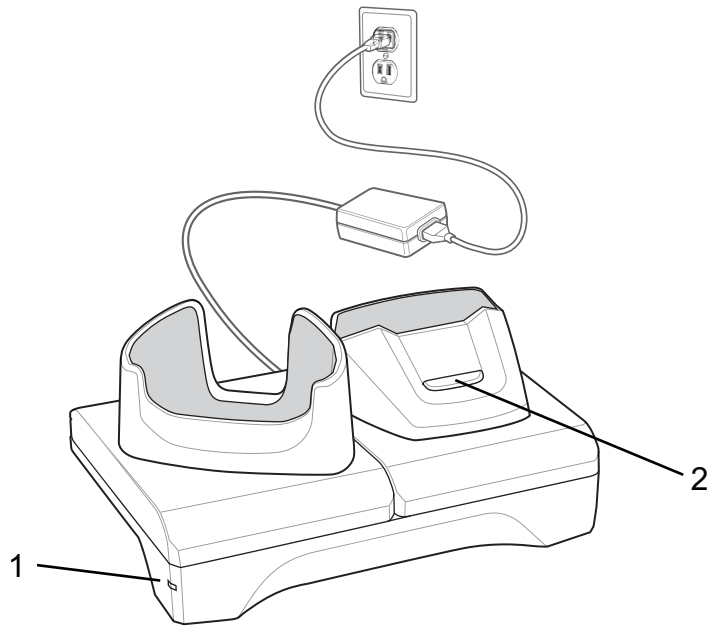
Figure 123: 2-Slot Charge Only Cradle

1	Power LED – Lights green indicating that the cradle is receiving power.
2	Spare battery Charging LED

Charging the Device

Procedure:

- 1 Insert the device into the slot to begin charging.

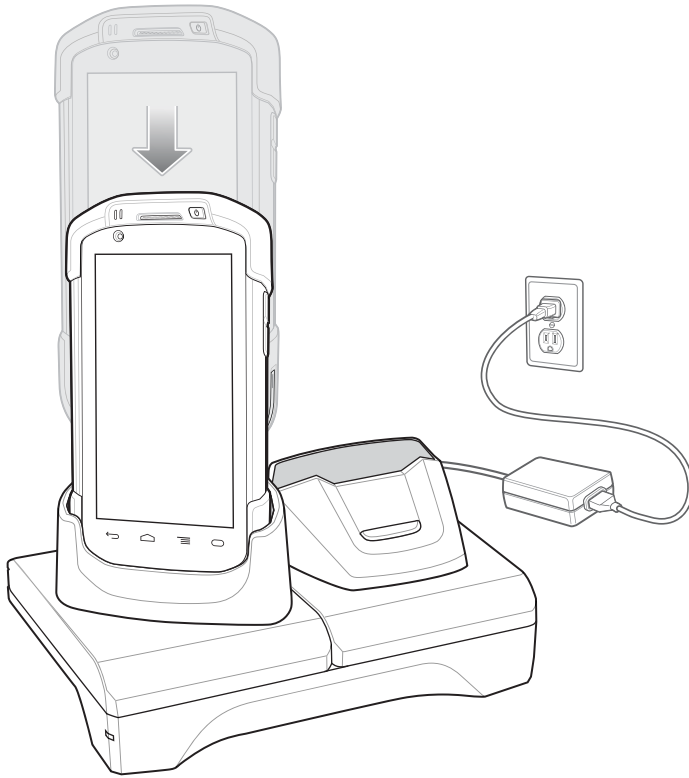
Figure 124: Battery Charging

- 2 Ensure the device is seated properly.

Charging the Spare Battery

Procedure:

- 1 Insert the battery into the right slot to begin charging.

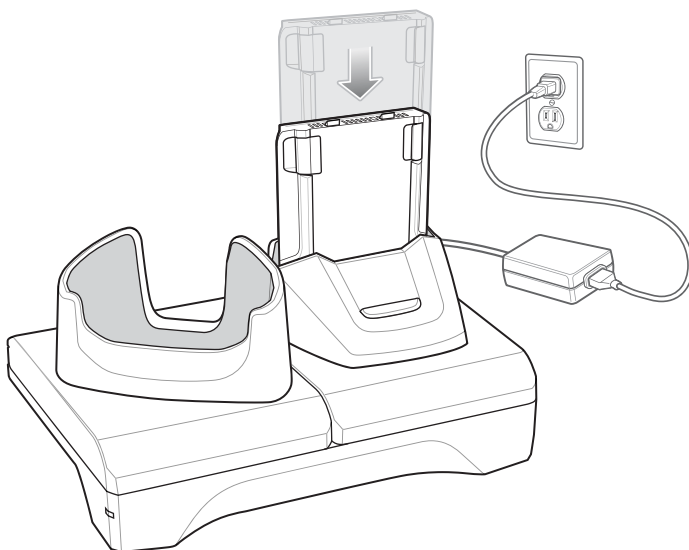
Figure 125: Spare Battery Charging

- 2 Ensure the battery is seated properly.

Battery Charging

Main Battery Charging

The device's Charging/Notification LED indicates the status of the battery charging in the device.

The 4,620 mAh battery fully charges in less than six hours at room temperature.

Spare Battery Charging

The Spare battery Charging LED on the cup indicates the status of the spare battery charging.

The 4,620 mAh battery fully charges in less than six hours at room temperature.

Table 13: Spare Battery Charging LED Indicators

LED	Indication
Slow Blinking Amber	Spare battery is charging.
Solid Green	Charging complete.
Fast Blinking Amber	Error in charging; check placement of spare battery.
Slow Blinking Red	Spare battery is charging and battery is at the end of useful life.
Solid Red	Charging complete and battery is at the end of useful life.
Fast Blinking Red	Error in charging; check placement of spare battery and battery is at the end of useful life.
Off	No spare battery in slot; spare battery not placed correctly; cradle is not powered.

Charging Temperature

Charge batteries in temperatures from 0 °C to 40 °C (32 °F to 104 °F). The device or cradle always performs battery charging in a safe and intelligent manner. At higher temperatures (e.g. approximately +37 °C (+98 °F)) the device or cradle may for small periods of time alternately enable and disable battery charging to keep the battery at acceptable temperatures. The device and cradle indicates when charging is disabled due to abnormal temperatures via its LED.

2-Slot USB/Ethernet Cradle

The 2-Slot USB/Ethernet Cradle:

- Provides 5.0 VDC power for operating the device.
- Charges the device's battery.
- Charges a spare battery.
- Connects the device to an Ethernet network.
- Provides communication to a host computer using a USB cable.

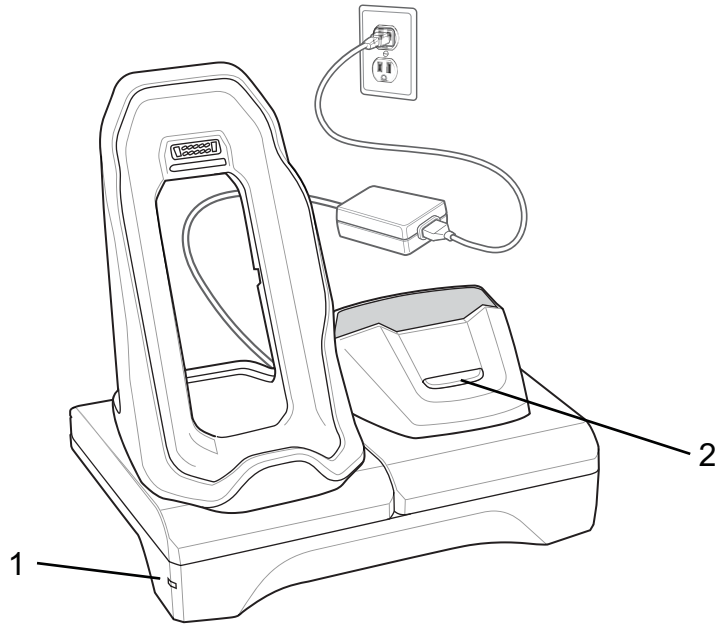

Note: Remove all attachments on the device, except the hand strap, before place onto the cradle.

Figure 126: 2-Slot USB/Ethernet Cradle

1	Power LED – Lights green indicating that the cradle is receiving power.
2	Spare Battery Charging LED

Charging the Device

Procedure:

- 1 Place the bottom of the device into the base.

Figure 127: Battery Charging

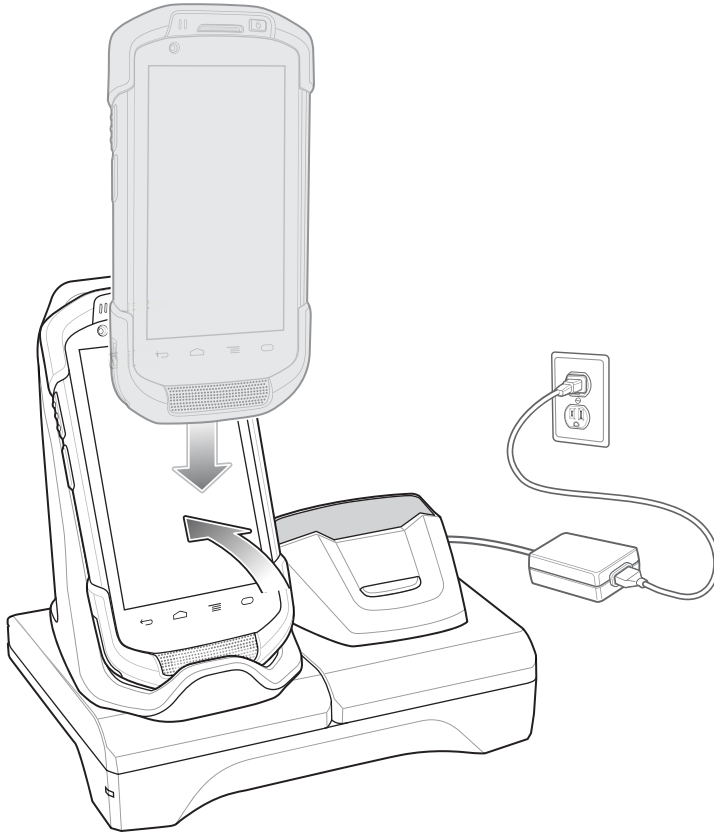

- 2 Rotate the top of the device until the connector on the back of the device mates with the connector on the cradle.
- 3 Ensure the device is connected properly. The charging Charging/Notification LED on the device begins blinking amber indicating that the device is charging.

Charging the Spare Battery

Procedure:

- 1 Insert the battery into the right slot to begin charging.

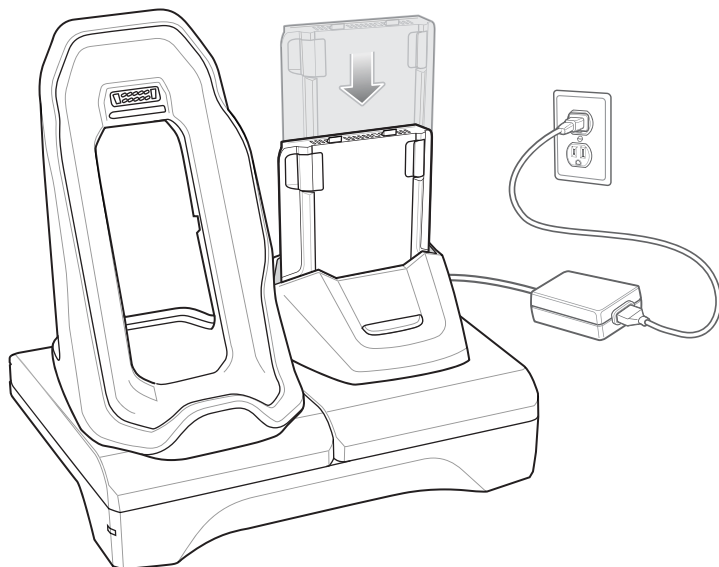
Figure 128: Spare Battery Charging

- 2 Ensure the battery is seated properly.

Battery Charging

Main Battery Charging

The device's Charging/Notification LED indicates the status of the battery charging in the device.

The 4,620 mAh battery fully charges in less than six hours at room temperature.

Spare Battery Charging

The Spare battery Charging LED on the cup indicates the status of the spare battery charging.

The 4,620 mAh battery fully charges in less than six hours at room temperature.

Table 14: Spare Battery Charging LED Indicators

LED	Indication
Slow Blinking Amber	Spare battery is charging.
Solid Green	Charging complete.
Fast Blinking Amber	Error in charging; check placement of spare battery.
Slow Blinking Red	Spare battery is charging and battery is at the end of useful life.
Solid Red	Charging complete and battery is at the end of useful life.
Fast Blinking Red	Error in charging; check placement of spare battery and battery is at the end of useful life.
Off	No spare battery in slot; spare battery not placed correctly; cradle is not powered.

Charging Temperature

Charge batteries in temperatures from 0 °C to 40 °C (32 °F to 104 °F). The device or cradle always performs battery charging in a safe and intelligent manner. At higher temperatures (e.g. approximately +37 °C (+98 °F)) the device or cradle may for small periods of time alternately enable and disable battery charging to keep the battery at acceptable temperatures. The device and cradle indicates when charging is disabled due to abnormal temperatures via its LED.

USB/Ethernet Communication

The 2-Slot USB/Ethernet Cradle provides both Ethernet communication with a network and USB communication with a host computer. Prior to using the cradle for Ethernet or USB communication. Ensure that the switch on the USB/Ethernet module is set properly.

Turn the cradle over to view the module.

Figure 129: 2-Slot USB/Ethernet Cradle Module Switch

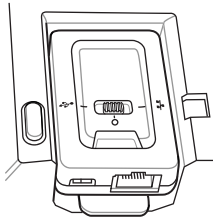

For Ethernet communication, slide the switch to the  position.

For USB communication, slide the switch to the  position.

Place the switch in the center position  to disable communications.

Ethernet LED Indicators

There are two LEDs on the USB/Ethernet Module RJ-45 connector. The green LED lights to indicate that the transfer rate is 100 Mbps. When the LED is not lit the transfer rate is 10 Mbps. The yellow LED blinks to indicate activity, or stays lit to indicate that a link is established. When it is not lit it indicates that there is no link.

Figure 130: LED Indicators

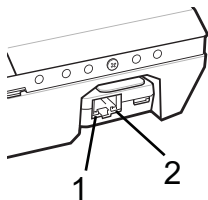

Table 15: USB/Ethernet Module LED Data Rate Indicators



Data Rate	(1) Yellow LED	(2) Green LED
100 Mbps	On/Blink	On
10 Mbps	On/Blink	Off

Establishing Ethernet Connection



Note: Refer to the *TC75 Integrator Guide* for information on configuring the Ethernet settings.

Procedure:

- 1 Touch .
- 2 Touch .
- 3 Touch **Ethernet**.
- 4 Slide the Ethernet switch to the **ON** position.
- 5 Insert the device into a slot.
The  icon appears in the Status bar.
- 6 Touch **Eth0** to view Ethernet connection details.

5-Slot Charge Only Cradle

The 5-Slot Charge Only Cradle:

- Provides 5 VDC power for operating the TC75.
- Simultaneously charges up to five TC75s and up to four TC75s and on 4-Slot Battery Charger using the Battery Charger Adapter. See the *TC75 Integrator Guide* for information on installing the 4-Slot Battery Charger onto the cradle.
- Consists of a cradle base and cups that can be configured for various charging requirements.

Figure 131: 5-Slot Charge Only Cradle

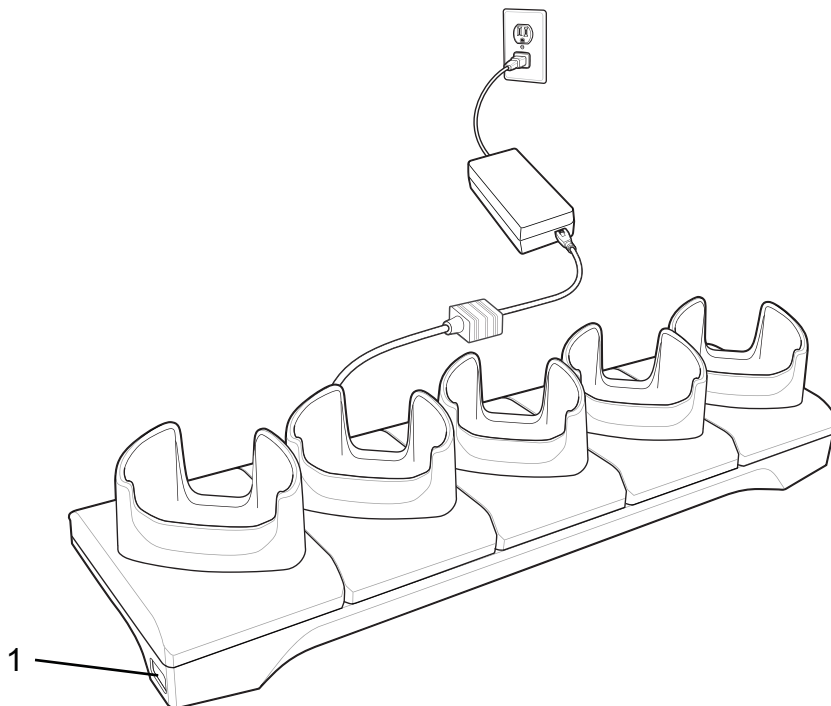

1	Power LED – Lights green when power is applied to cradle.
---	---

Charging the TC75

Procedure:

- 1 Insert the TC75 into a slot to begin charging.

Figure 132: TC75 Battery Charging

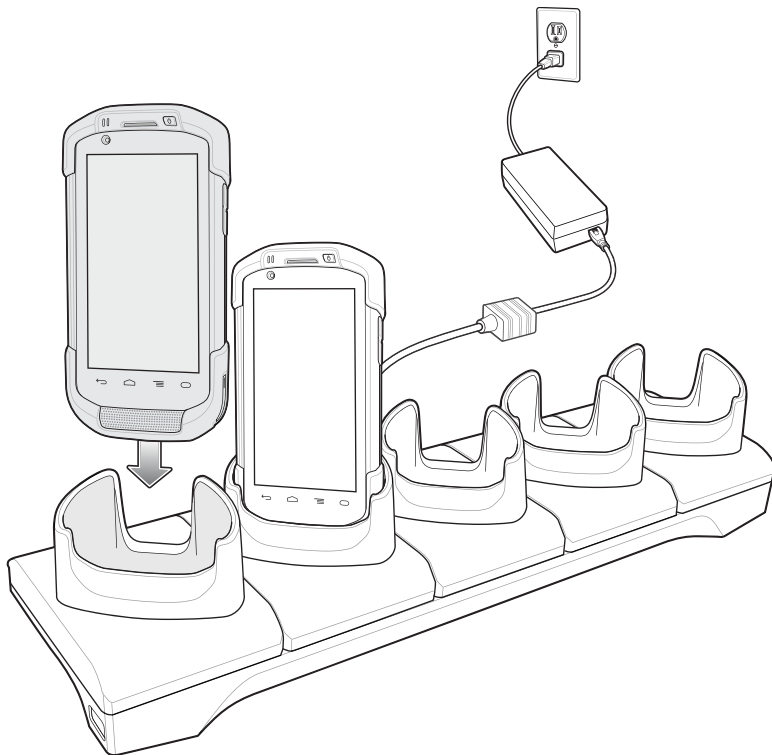
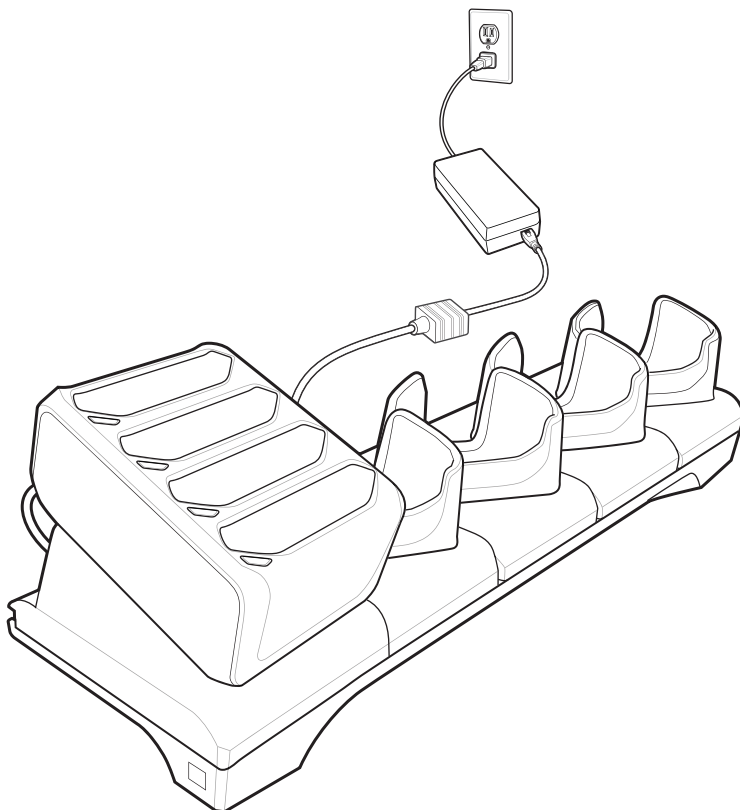

Figure 133: 5-Slot Charge Only Cradle with Four Slot Battery Charger

- 2 Ensure the TC75 is seated properly.



Note: See the *TC75 Integrator Guide* for information on installing the 4-Slot Battery Charger onto the cradle.

Battery Charging

Main Battery Charging

The device's Charging/Notification LED indicates the status of the battery charging in the device.

The 4,620 mAh battery fully charges in less than six hours at room temperature.

Spare Battery Charging

The Spare battery Charging LED on the cup indicates the status of the spare battery charging.

The 4,620 mAh battery fully charges in less than six hours at room temperature.

Table 16: Spare Battery Charging LED Indicators

LED	Indication
Slow Blinking Amber	Spare battery is charging.
Solid Green	Charging complete.
Fast Blinking Amber	Error in charging; check placement of spare battery.

Table continued...

LED	Indication
Slow Blinking Red	Spare battery is charging and battery is at the end of useful life.
Solid Red	Charging complete and battery is at the end of useful life.
Fast Blinking Red	Error in charging; check placement of spare battery and battery is at the end of useful life.
Off	No spare battery in slot; spare battery not placed correctly; cradle is not powered.

Charging Temperature

Charge batteries in temperatures from 0 °C to 40 °C (32 °F to 104 °F). The device or cradle always performs battery charging in a safe and intelligent manner. At higher temperatures (e.g. approximately +37 °C (+98 °F)) the device or cradle may for small periods of time alternately enable and disable battery charging to keep the battery at acceptable temperatures. The device and cradle indicates when charging is disabled due to abnormal temperatures via its LED.

5-Slot Ethernet Cradle



Caution: Ensure that you follow the guidelines for battery safety described in [Battery Safety Guidelines on page 183](#).

The 5-Slot Ethernet Cradle:

- Provides 5.0 VDC power for operating the device.
- Connects the device (up to five) to an Ethernet network.
- Simultaneously charges up to five TC75s and up to four TC75s and on 4-Slot Battery Charger using the Battery Charger Adapter. See the *TC75 Integrator Guide* for information on installing the 4-Slot Battery Charger onto the cradle.

Figure 134: 5-Slot Ethernet Cradle

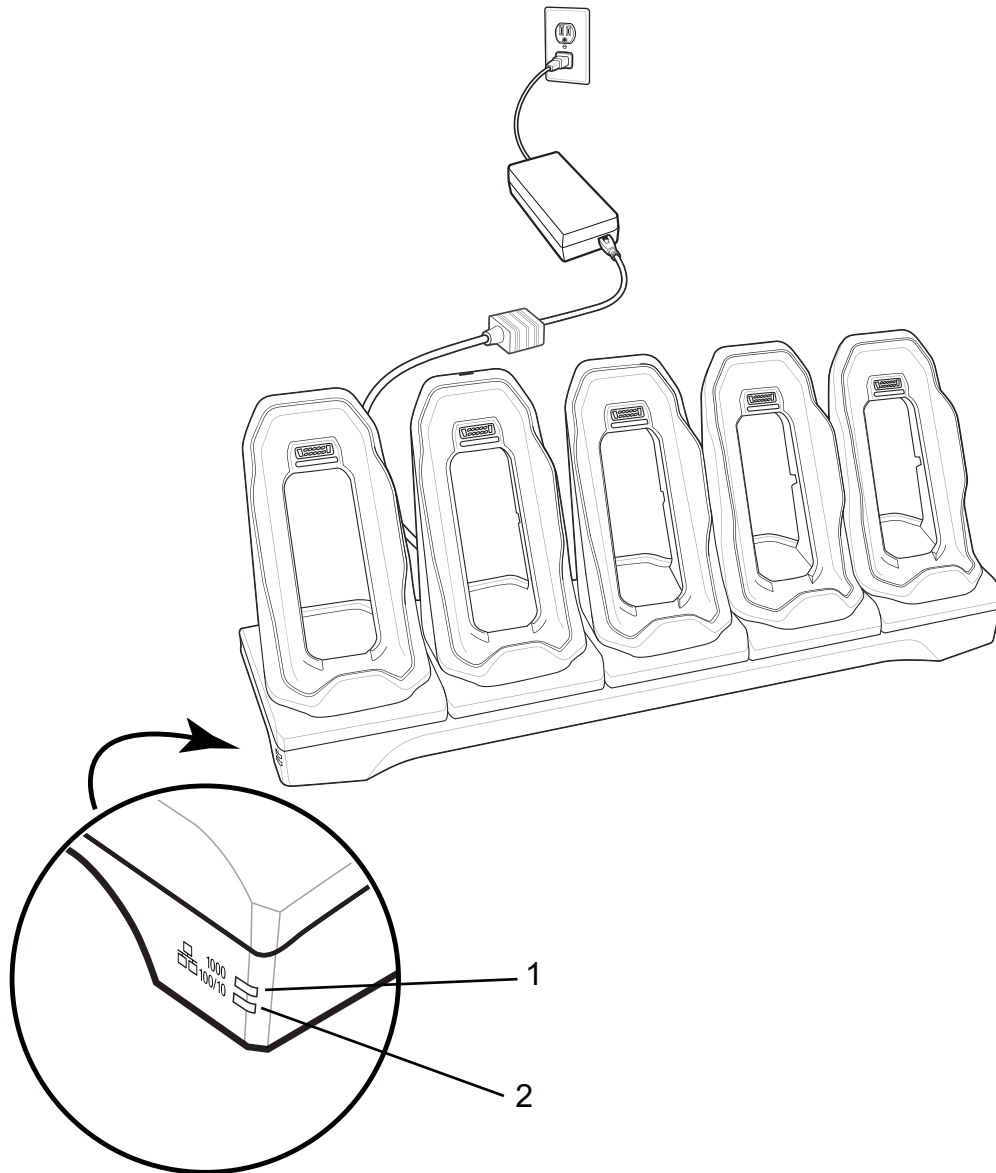

1	1000 LED – Indicates 1 Gbps data rate.
2	100/10 LED – Indicates 100 Mbps or 10 Mbps data rate.

Charging the TC75

Procedure:

- 1 Insert the TC75 into a slot to begin charging.

Figure 135: TC75 Battery Charging

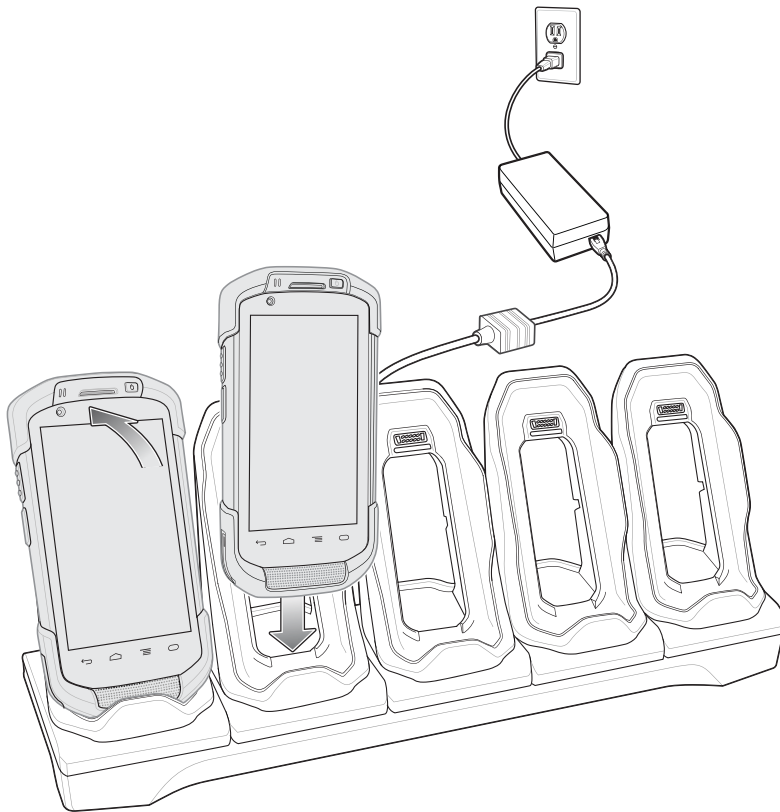

- 2 Ensure the TC75 is seated properly.

Figure 136: 5-Slot Ethernet Cradle with 4-Slot Battery Charger

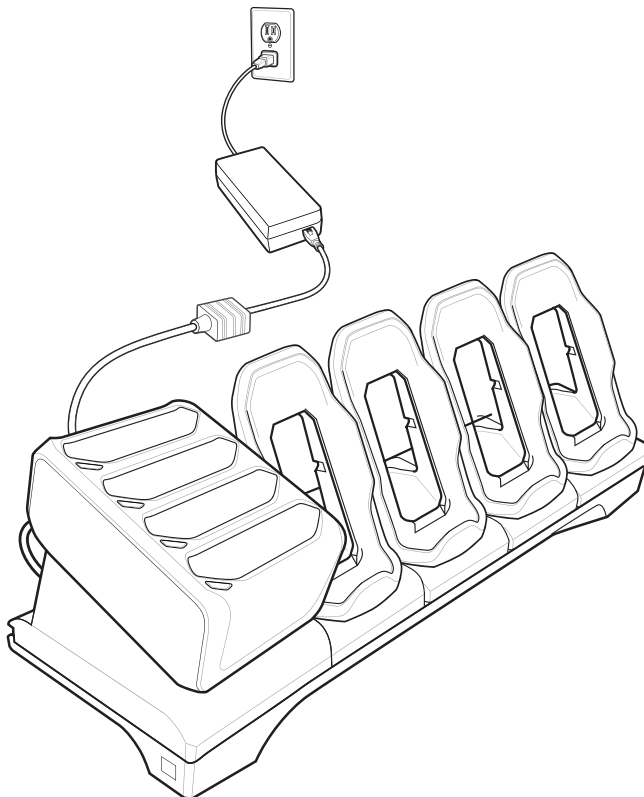



Note: See the *TC75 Integrator Guide* for information on installing the 4-Slot Battery Charger onto the cradle.

Battery Charging

Main Battery Charging

The device's Charging/Notification LED indicates the status of the battery charging in the device.

The 4,620 mAh battery fully charges in less than six hours at room temperature.

Spare Battery Charging

The Spare battery Charging LED on the cup indicates the status of the spare battery charging.

The 4,620 mAh battery fully charges in less than six hours at room temperature.

Table 17: Spare Battery Charging LED Indicators

LED	Indication
Slow Blinking Amber	Spare battery is charging.
Solid Green	Charging complete.
Fast Blinking Amber	Error in charging; check placement of spare battery.
Slow Blinking Red	Spare battery is charging and battery is at the end of useful life.
Solid Red	Charging complete and battery is at the end of useful life.
Fast Blinking Red	Error in charging; check placement of spare battery and battery is at the end of useful life.
Off	No spare battery in slot; spare battery not placed correctly; cradle is not powered.

Charging Temperature



Charge batteries in temperatures from 0 °C to 40 °C (32 °F to 104 °F). The device or cradle always performs battery charging in a safe and intelligent manner. At higher temperatures (e.g. approximately +37 °C (+98 °F)) the device or cradle may for small periods of time alternately enable and disable battery charging to keep the battery at acceptable temperatures. The device and cradle indicates when charging is disabled due to abnormal temperatures via its LED.

Establishing Ethernet Connection



Note: Refer to the *TC75 Integrator Guide* for information on configuring the Ethernet settings.

Procedure:

- 1 Touch .
- 2 Touch .
- 3 Touch **Ethernet**.
- 4 Slide the Ethernet switch to the **ON** position.
- 5 Insert the device into a slot.
The  icon appears in the Status bar.

- 6 Touch **Eth0** to view Ethernet connection details.

LED Indicators

There are two green LEDs on the side of the cradle. These green LEDs light and blink to indicate the data transfer rate.

Table 18: LED Data Rate Indicators

Data Rate	1000 LED	100/10 LED
1 Gbps	On/Blink	Off
100 Mbps	Off	On/Blink
10 Mbps	Off	On/Blink

4-Slot Battery Charger

This section describes how to use the 4-Slot Battery Charger to charge up to four TC75 batteries.

Charging Spare Batteries

Procedure:

- 1 Connect the charger to a power source.
- 2 Insert the battery into a battery charging well and gently press down on the battery to ensure proper contact.

Figure 137: 4-Slot Battery Charger

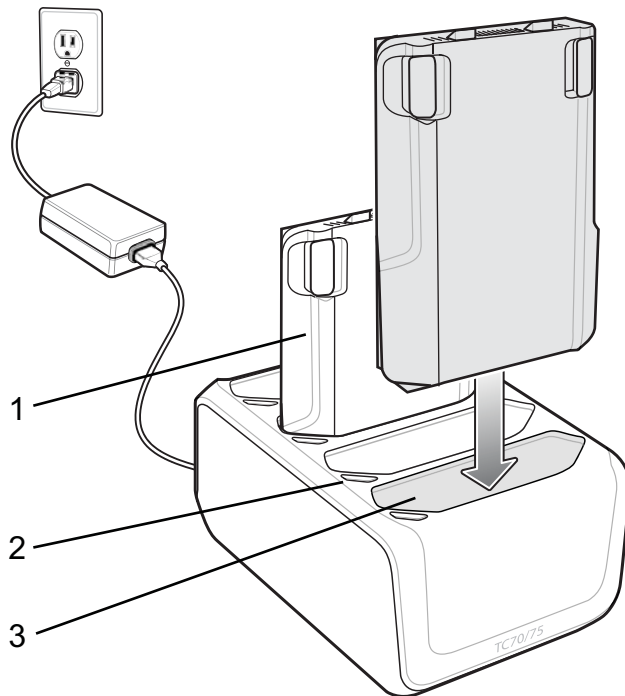

Item	Description
1	TC75 Battery
2	Battery Charge LED
3	Battery Slot

Battery Charging

Spare Battery Charging

Each Battery Charging LED indicates the status of the battery charging in each slot. The table below describes the Battery Charging LED status.

The 4,620 mAh battery fully charges in less than six hours at room temperature.

Table 19: Battery LED Charging Indicators

LED	Indication
Slow Blinking Amber	Spare battery is charging.
Solid Green	Charging complete.
Fast Blinking Amber	Error in charging; check placement of spare battery.
Slow Blinking Red	Spare battery is charging and battery is at the end of useful life.
Solid Red	Charging complete and battery is at the end of useful life.
Fast Blinking Red	Error in charging; check placement of spare battery and battery is at the end of useful life.
Off	No spare battery in slot; spare battery not placed correctly; cradle is not powered.

Charging Temperature

Charge batteries in temperatures from 0 °C to 40 °C (32 °F to 104 °F). The battery charger always performs battery charging in a safe and intelligent manner. At higher temperatures (e.g. approximately +37 °C (+98 °F)) the battery charger may for small periods of time alternately enable and disable battery charging to keep the battery at acceptable temperatures. The battery charger indicates when charging is disabled due to abnormal temperatures via its LED.

Magnetic Stripe Reader

The MSR snaps on to the back of the TC75 and removes easily when not in use. When attached to the TC75, the MSR allows the TC75 to capture data from magnetic stripe cards.

For battery optimization, remove when not in use.

Attaching the MSR

Procedure:

- 1 Align the top mounting points on the MSR with the mounting slots on the TC75.

Figure 138: MSR Installation

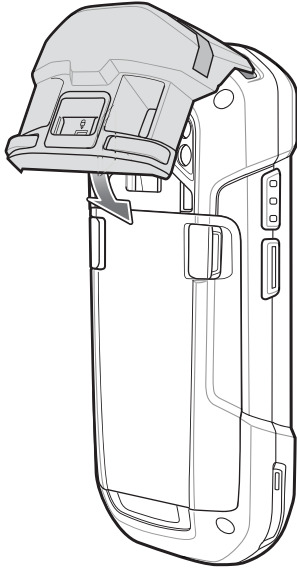

- 2 Rotate the MSR down and press down until it snaps into position.
- 3 Using a flat end plastic tool, slide the lock switch down to lock the MSR.

Figure 139: Lock MSR

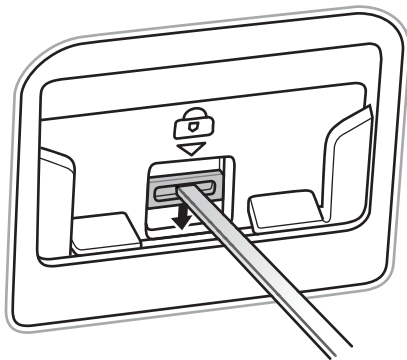

Removing the MSR

Procedure:

- 1 Using a flat end plastic tool, slide the lock switch up to unlock the MSR.

Figure 140: Unlock MSR

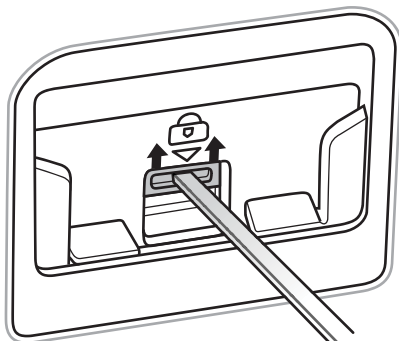

- 2 Press the two release buttons.

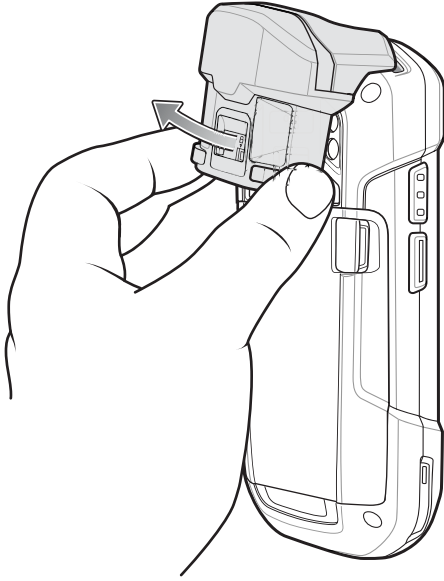
Figure 141: Remove MSR

- 3 Rotate the MSR away from the TC75 and lift.

Reading Magnetic Stripe Cards

Use the integrated MSR to read magnetic stripe card.

Procedure:

- 1 Ensure that **MSR input** is enabled in DataWedge and the cursor is in a text field.
- 2 Grip TC75 firmly in one hand.
- 3 Hold magnetic stripe card firmly in the other hand.
- 4 Align the magnetic stripe on the card away from the display and swipe the card smoothly in either direction.

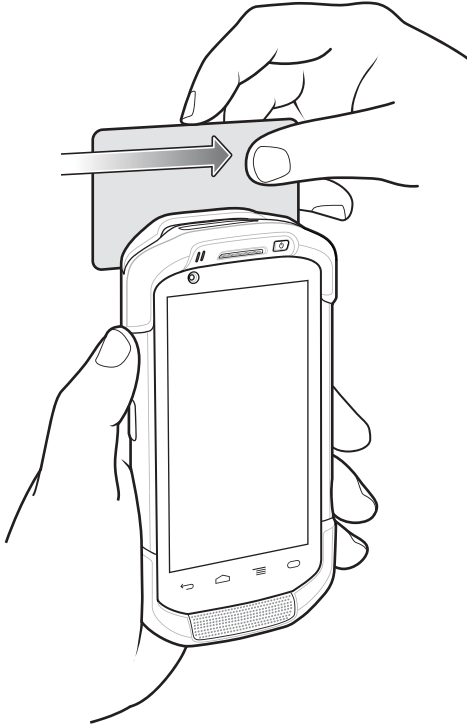
Figure 142: Swiping a Magnetic Stripe Card

5 Depending upon the application, the captured data appears.

2.5 mm Audio Adapter

The 2.5 mm Audio Adapter snaps onto the back of the TC75 and removes easily when not in use. When attached to the TC75, the Audio Adapter allows a user to connect a wired headset to the TC75.

Attaching the 2.5 mm Audio Adapter

Procedure:

- 1 Align the top mounting points on the Audio Adapter with the mounting slots on the TC75.

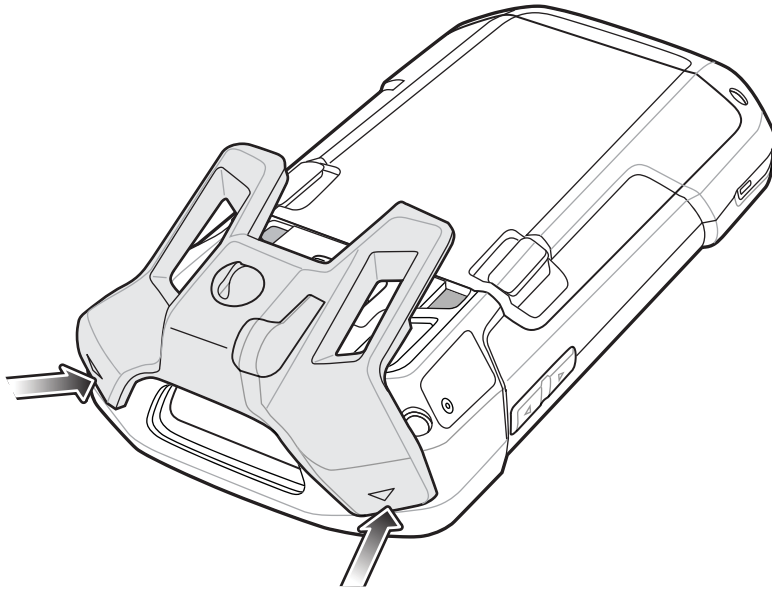
Figure 143: Audio Adapter Installation

- 2 Rotate the Audio Adapter down and press down until it snaps into position.

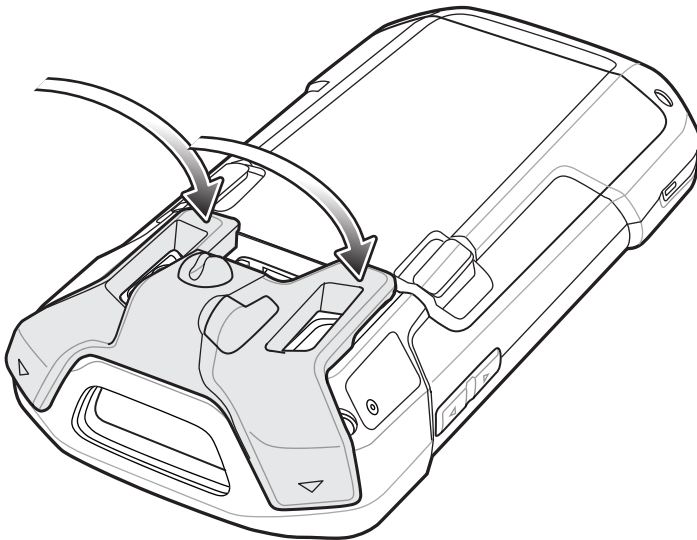
Figure 144: Rotate Audio Adapter onto TC75

Connecting a Headset to the Audio Adapter

Procedure:

- 1 Lift the rubber plug from the audio jack.
- 2 Insert the headset plug into the jack on the Audio Adapter.

Figure 145: Connect Headset to Audio Adapter

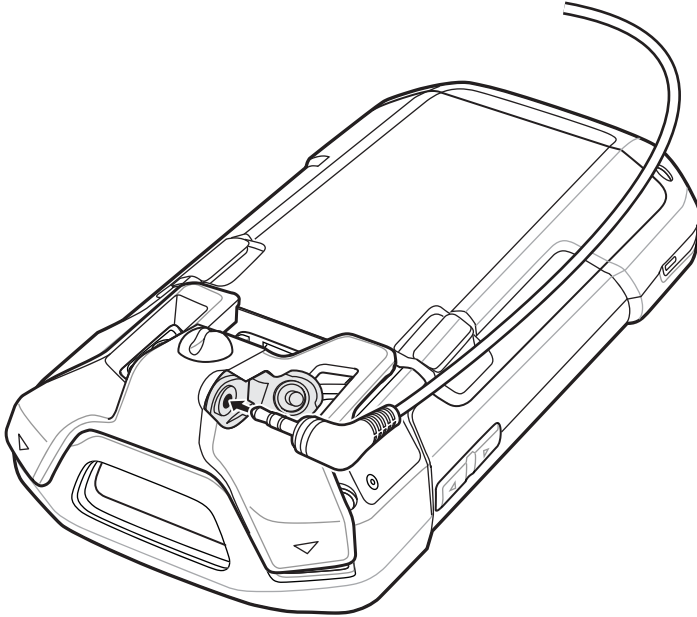

- 3 Press the headset wire into the wire holder on the Audio Adapter.

Figure 146:

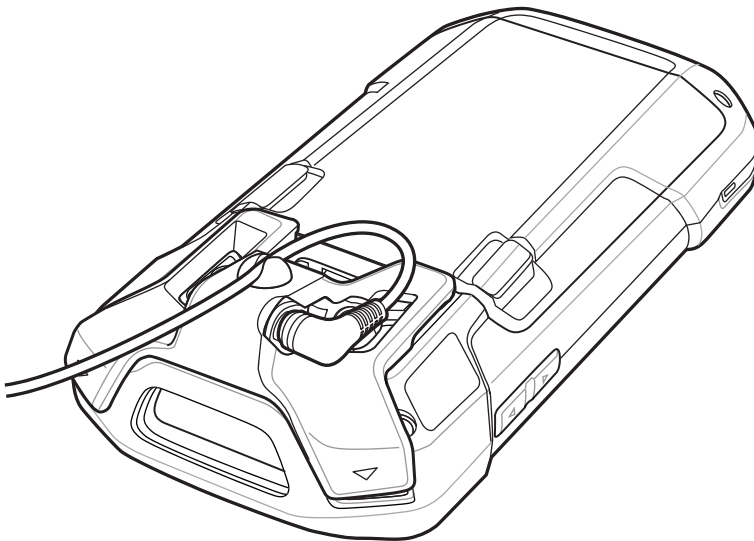

Device with Audio Adapter in Holster

When using the TC75 and the audio adapter in a holster, ensure that the display faces in and the headset cable is securely attached to the audio adapter.

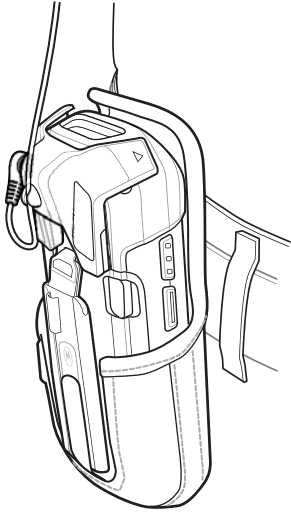
Figure 147: Device with Audio Adapter in Holster

Removing the 2.5 mm Audio Adapter

Procedure:

- 1 Disconnect headset plug from 2.5 mm Audio Adapter.
- 2 Lift the bottom of the Audio Adapter away from the TC75.

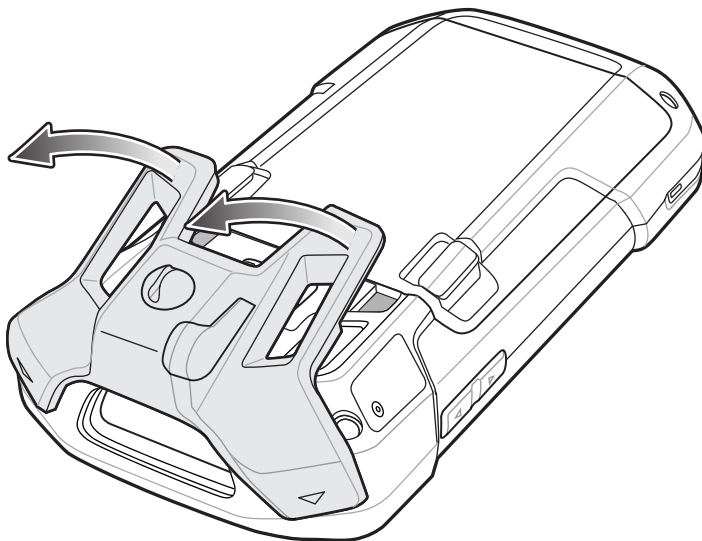
Figure 148: Remove Audio Adapter from TC75

- 3 Remove Audio Adapter from the TC75.

3.5 mm Audio Adapter

The 3.5 mm Audio Adapter snaps onto the back of the TC75 and removes easily when not in use. When attached to the TC75, the 3.5 mm Audio Adapter allows a user to connect a wired headset to the TC75.

Connecting a Headset to the 3.5 mm Audio Adapter

Procedure:

- 1 Connect the Quick Disconnect connect of the headset to the Quick Disconnect connector of the 3.5 mm Quick Disconnect Adapter Cable.

Figure 149: Connect Headset to Adapter Cable



- 2 Connect the audio jack of the 3.5 mm Quick Disconnect Adapter Cable to the 3.5 mm Audio Adapter.

Figure 150: Connect Adapter Cable to Audio Adapter

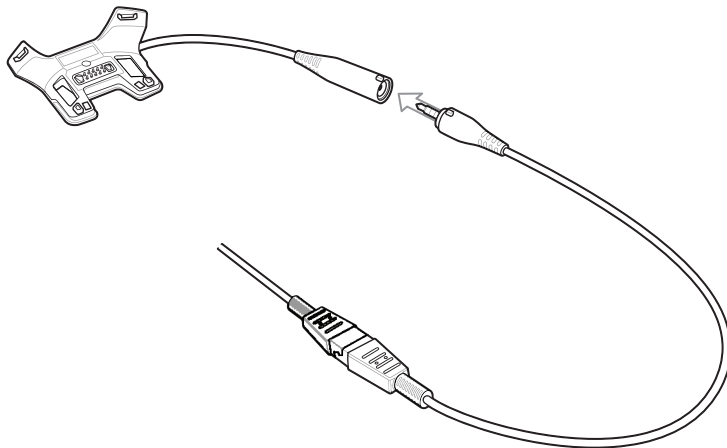

Attaching the 3.5 mm Audio Adapter

Procedure:

- 1 Align the top mounting points on the 3.5 mm Audio Adapter with the mounting slots on the TC75.

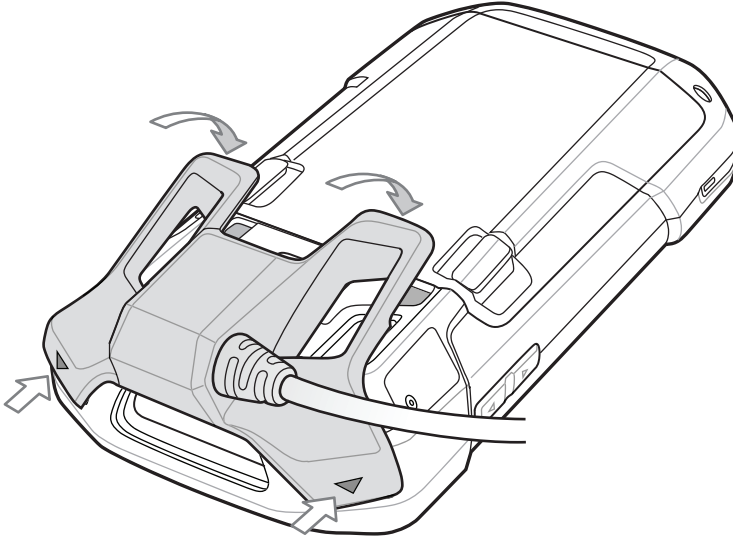
Figure 151: Audio Adapter Installation

- 2 Rotate the Audio Adapter down and press down until it snaps into position.

Device with 3.5 mm Audio Adapter in Holster

When using the TC75 and the audio adapter in a holster, ensure that the display faces in and the headset cable is securely attached to the audio adapter.

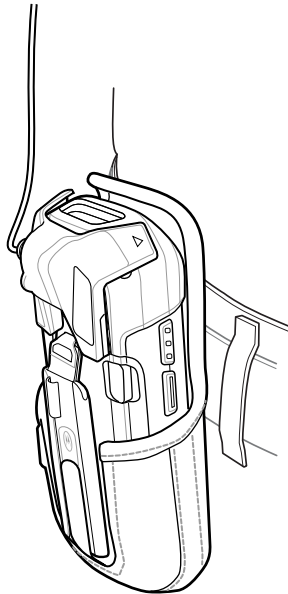
Figure 152: Device with 3.5 mm Audio Adapter in Holster

Removing the 3.5 mm Audio Adapter

Procedure:

- 1 Disconnect headset plug from 3.5 mm Audio Adapter.
- 2 Lift the bottom of the Audio Adapter away from the TC75.

Figure 153: Remove Audio Adapter from TC75

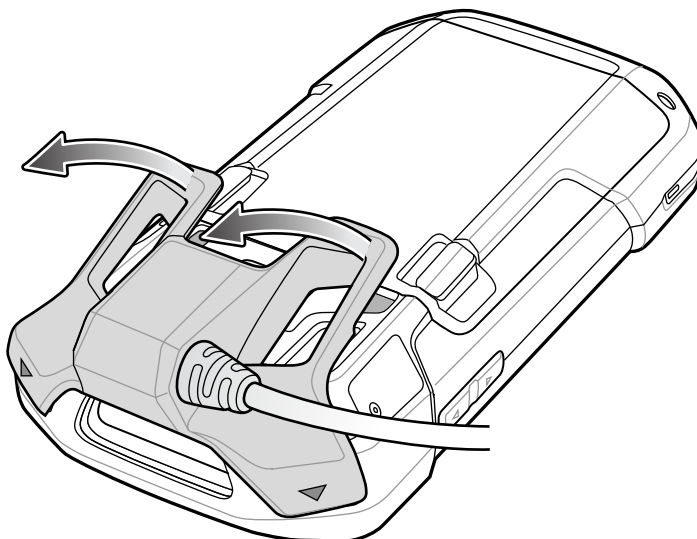

- 3 Remove Audio Adapter from the TC75.

Snap-On USB Cable

The Snap-On USB Cable snaps on to the back of the TC75 and removes easily when not in use. When attached to the TC75, the Snap-On USB Cable allows the TC75 to transfer data to a host computer and provide power for charging the TC75.

Connecting to TC75

Procedure:

- 1 Align the top mounting points on the cable with the mounting slots on the TC75.

Figure 154: Cable Installation

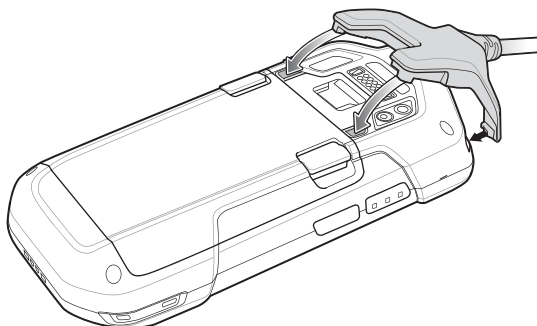

- 2 Rotate the cable down and press until it snaps into place. Magnetics hold the cable to the TC75.

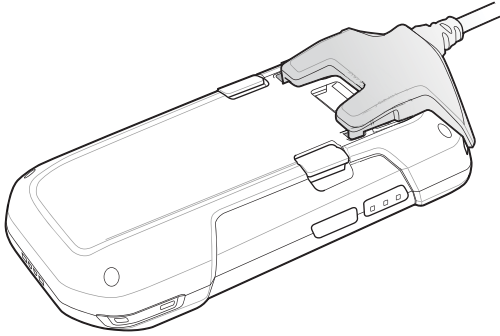
Figure 155: Cable Attached to TC75

USB Communication

Procedure:

- 1 Connect the Snap-On USB Cable to the TC75.

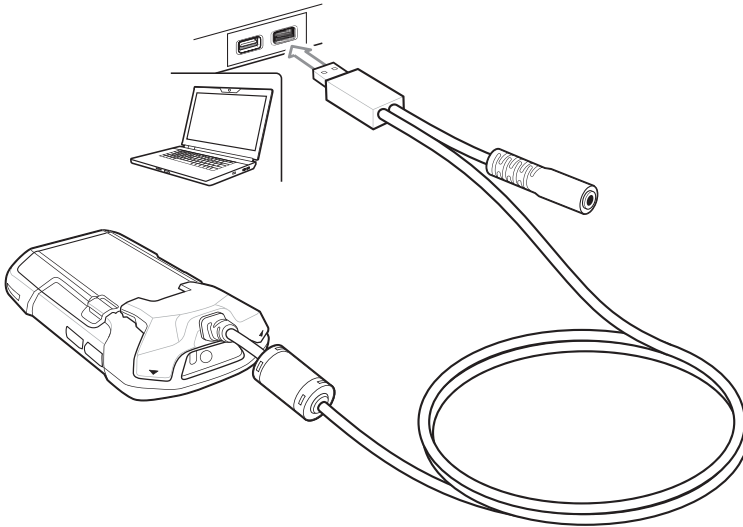
Figure 156: Cable Removed from TC75

- 2 Connect the USB connector of the cable to a host computer.

Charging the TC75

Procedure:

- 1 Connect the Snap-On USB Cable to the TC75.
- 2 Connect the power supply to the Snap-On USB Cable

Figure 157: Power Setup

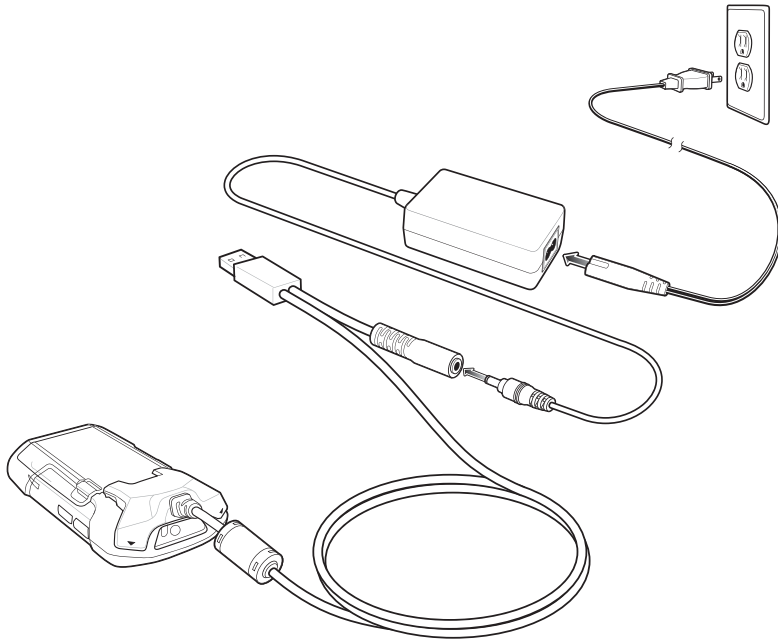

- 3 Connect to the power supply to an AC outlet.

Disconnecting from TC75

Procedure:

- 1 Press down on the cable.

Figure 158: Press Down on Cable

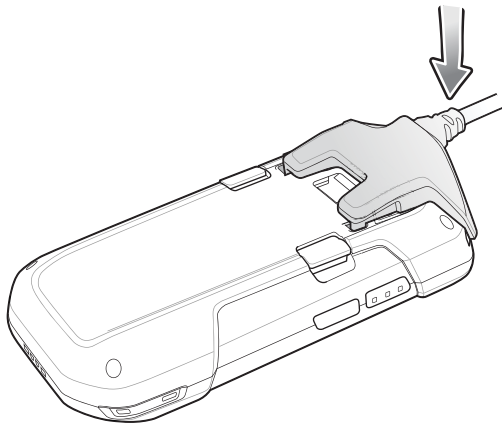

- 2 Rotate away from the TC75. The magnetics release the cable from the TC75.

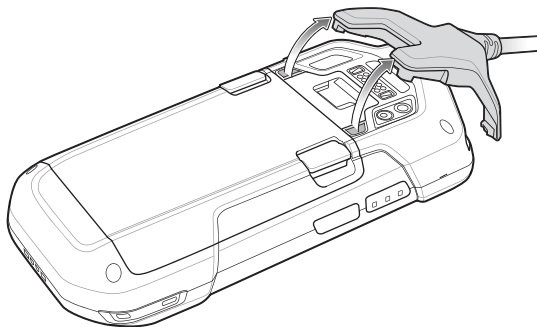
Figure 159: Remove Cable from TC75

Battery Charging

Main Battery Charging

The device's Charging/Notification LED indicates the status of the battery charging in the device.

The 4,620 mAh battery fully charges in less than six hours at room temperature.

Charging Temperature

Charge batteries in temperatures from 0 °C to 40 °C (32 °F to 104 °F). The device always performs battery charging in a safe and intelligent manner. At higher temperatures (e.g. approximately +37 °C (+98 °F)) the device may for small periods of time alternately enable and disable battery charging to keep the battery at acceptable temperatures. The device indicates when charging is disabled due to abnormal temperatures via its LED.

Charging Cable Cup

This section describes how to use the Charging Cable Cup to charge the TC75.

Charging the TC75

Procedure:

- 1 Insert the TC75 into the cup of the Charging Cable Cup.

Figure 160: TC75 Charging

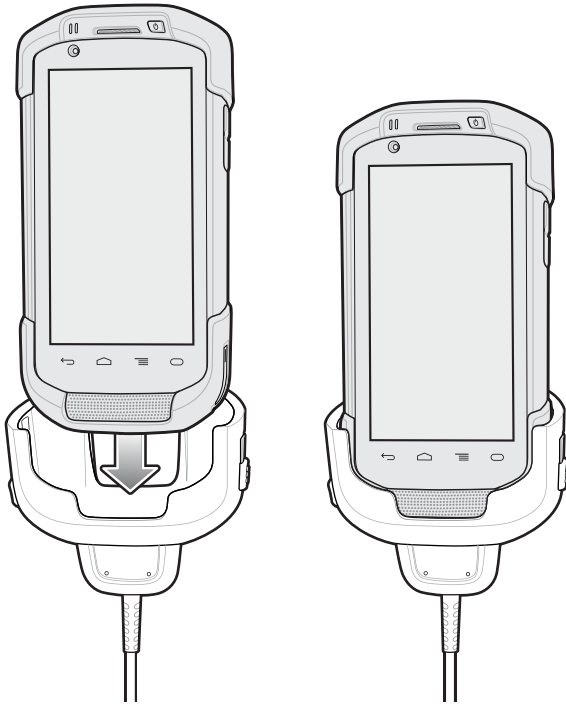

- 2 Ensure the TC75 is seated properly.
- 3 Slide the two yellow locking tabs up to lock the cable to the TC75.

Figure 161: Lock Cable Cup

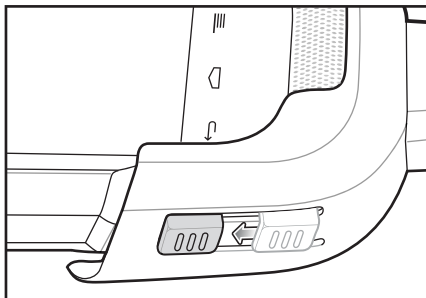

- 4 Connect the power supply to the Charging Cable Cup and to a power source.

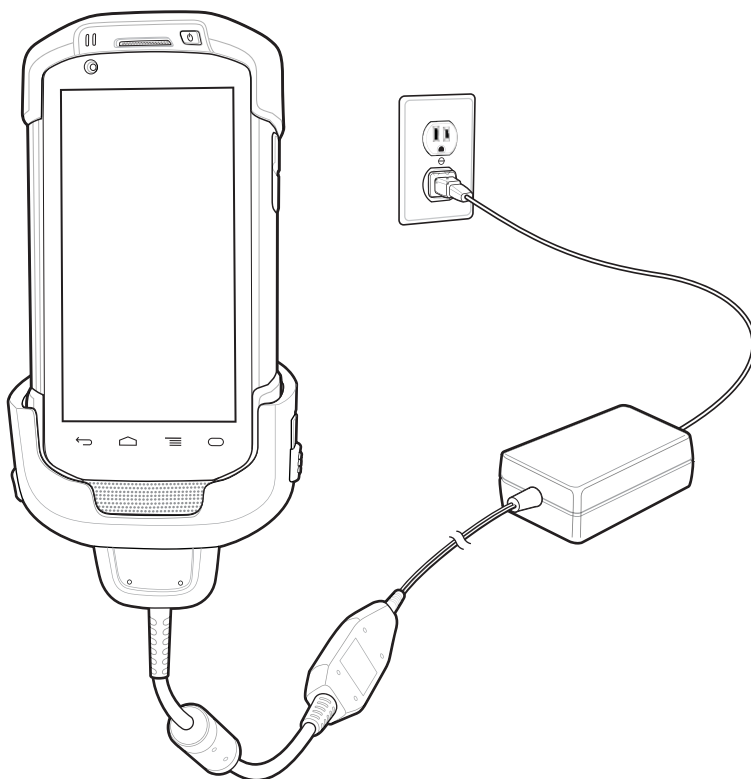
Figure 162: Connect Cable to Power Supply

Battery Charging

Main Battery Charging

The device's Charging/Notification LED indicates the status of the battery charging in the device.

The 4,620 mAh battery fully charges in less than six hours at room temperature.

Charging Temperature

Charge batteries in temperatures from 0 °C to 40 °C (32 °F to 104 °F). The device always performs battery charging in a safe and intelligent manner. At higher temperatures (e.g. approximately +37 °C (+98 °F)) the device may for small periods of time alternately enable and disable battery charging to keep the battery at acceptable temperatures. The device indicates when charging is disabled due to abnormal temperatures via its LED.

Snap-On DEX Cable

The Snap-On DEX Cable snaps on to the back of the TC75 and removes easily when not in use. When attached to the TC75, the Snap-On DEX Cable provides electronic data exchange with devices such as vending machines.

Connecting to TC75

Procedure:

- 1 Align the top mounting points on the cable with the mounting slots on the TC75.

Figure 163: Cable Installation

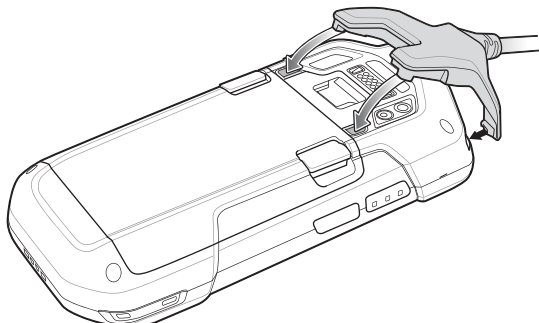

- 2 Rotate the cable down and press until it snaps into place. Magnetics hold the cable to the TC75.

Figure 164: Cable Attached to TC75

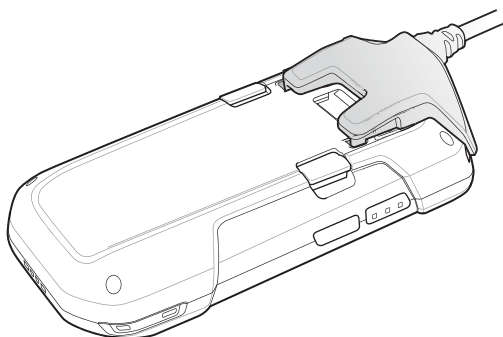

DEX Communication

Procedure:

- 1 Connect the Snap-On DEX Cable to the TC75.
- 2 Connect the DEX connector of the cable to a device such as a vending machine.

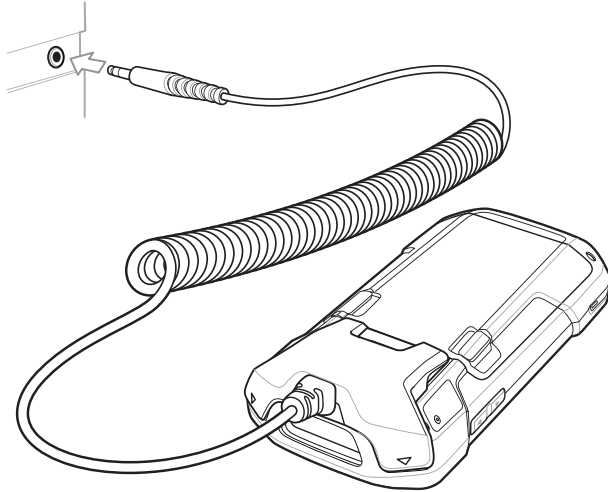
Figure 165: DEX Cable Connection

Disconnecting from TC75

Procedure:

- 1 Press down on the cable.

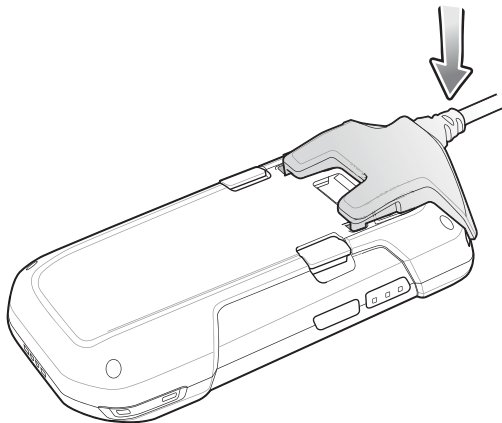
Figure 166: Press Down on Cable

- 2 Rotate away from the TC75. The magnetics release the cable from the TC75.

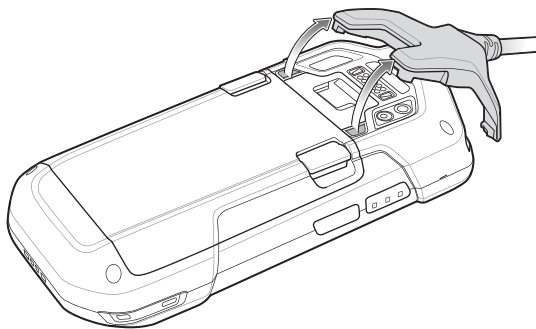
Figure 167: Remove Cable from TC75

Trigger Handle

The Trigger Handle adds a gun-style handle with a scanning trigger to the device. It increases comfort when using the device in scan-intensive applications for extended periods of time.

Figure 168: Trigger Handle

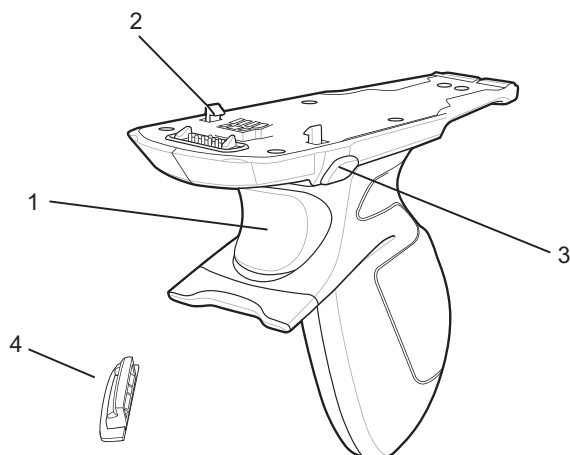

1	Trigger
2	Latch
3	Release button
4	Trigger Handle Plate

Installing the Trigger Handle Plate

Procedure:

- 1 Press and hold the **Power** button until the menu appears.
- 2 Touch **Power off**.
- 3 Touch **OK**.
- 4 Press in the two battery latches.
- 5 Lift the battery from the device.
- 6 Remove the hand strap filler plate from the hand strap slot. Store the hand strap filler plate in a safe place for future replacement.

Figure 169: Remove Hand Strap Plate

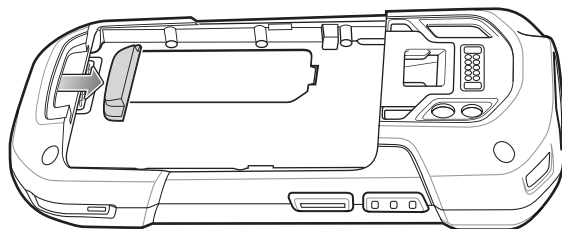

- 7 Insert the replacement hand strap plate into the hand strap slot.

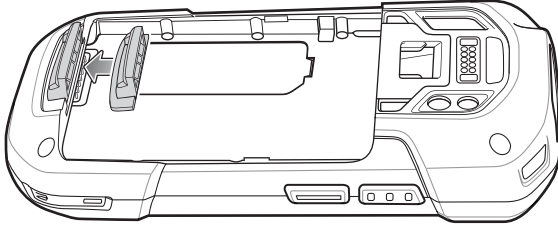
Figure 170: Insert Trigger Handle Plate

- 8 Insert the battery, bottom first, into the battery compartment in the back of the device.
- 9 Rotate the top of the battery into the battery compartment.
- 10 Press the battery down into the battery compartment until the battery release latches snap into place.

Inserting the Device into the Trigger Handle

Procedure:

- 1 Align the back of the Trigger handle with the Trigger Mounting Plate.

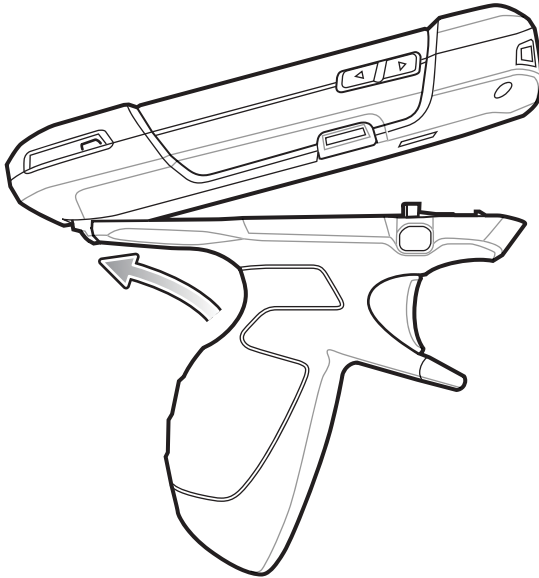
Figure 171: Connect Device to Trigger Handle

- 2 Press the two release latches.
- 3 Rotate the device down and press down until it snaps into place.

Figure 172: Rotate Device onto Trigger Handle

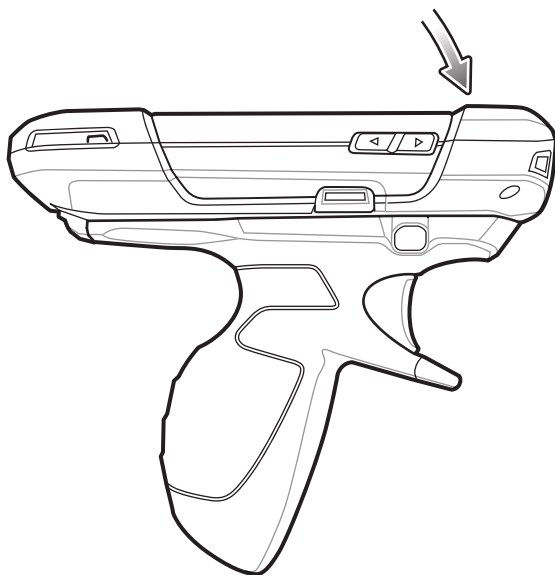

Removing the Device from the Trigger Handle

Procedure:

- 1 Press both Trigger Handle release latches.

Figure 173: Press Release Latches

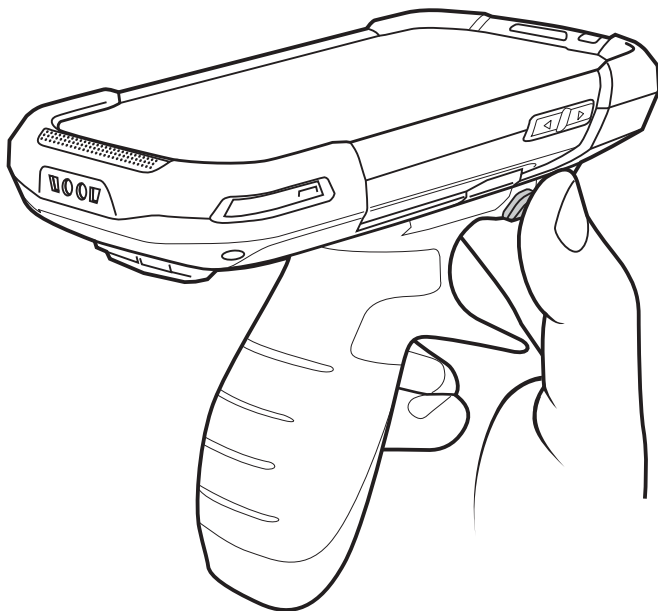

- 2 Rotate the device up and remove from the Trigger handle.
- 3 Rotate the device down and press down until it snaps into place.

Figure 174: Rotate Device onto Trigger Handle

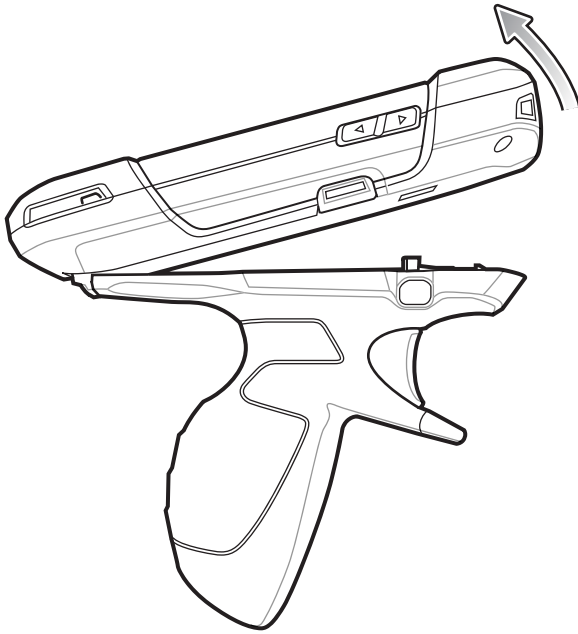

Vehicle Charging Cable Cup

This section describes how to use the Vehicle Charging Cable Cup to charge the TC75.

Figure 175: Vehicle Charging Cable Cup

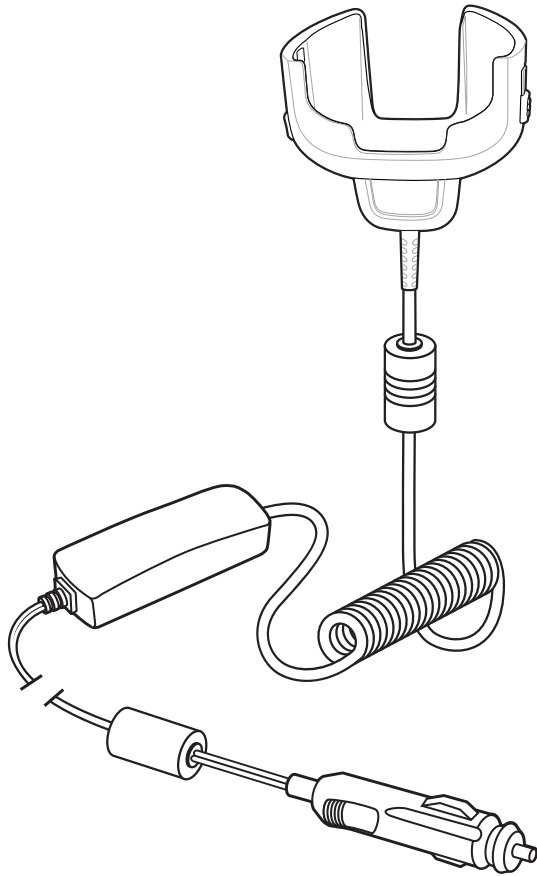

Charging the TC75

Procedure:

- 1 Insert the TC75 into the cup of the Vehicle Charging Cable.

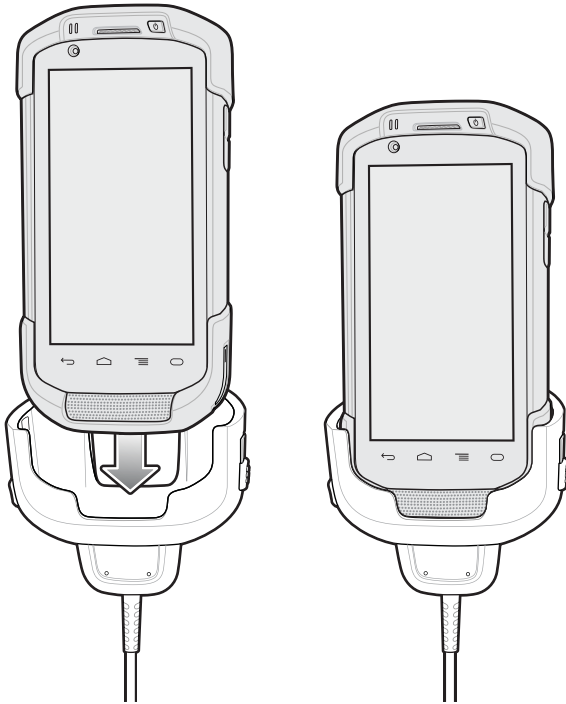
Figure 176: TC75 Charging

- 2 Ensure the TC75 is seated properly.
- 3 Slide the two yellow locking tabs up to lock the cable to the TC75.

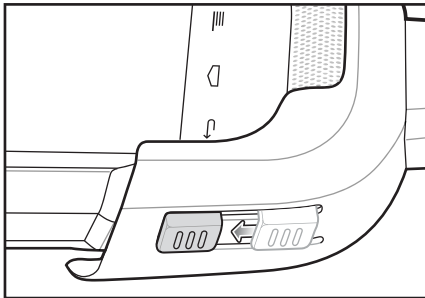
Figure 177: Lock Cable Cup

- 4 Insert the Cigarette Lighter plug into the vehicle cigarette lighter socket.

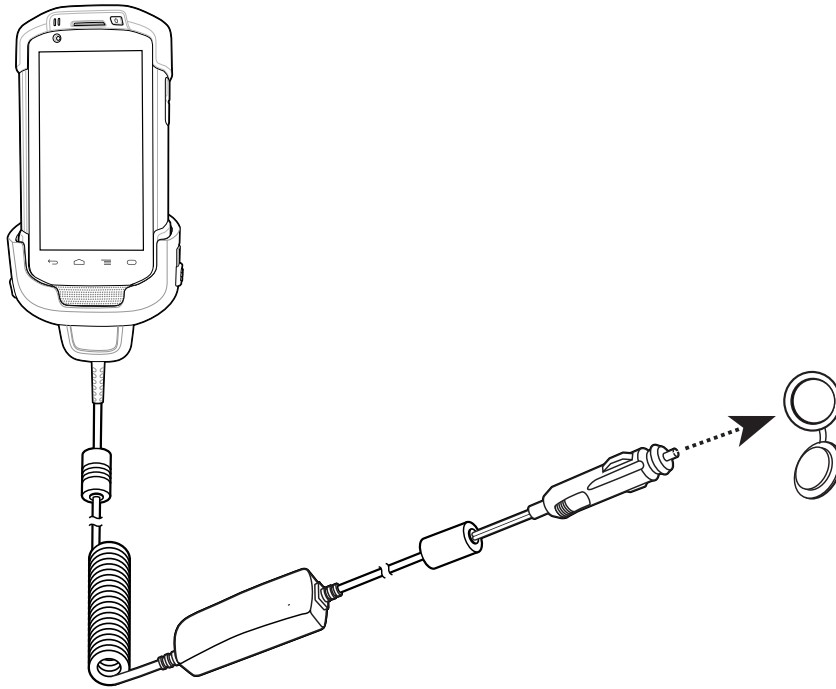
Figure 178: Connect Cable to Vehicle Power Source

Battery Charging

Main Battery Charging

The device's Charging/Notification LED indicates the status of the battery charging in the device.

The 4,620 mAh battery fully charges in less than six hours at room temperature.

Charging Temperature

Charge batteries in temperatures from 0 °C to 40 °C (32 °F to 104 °F). The device always performs battery charging in a safe and intelligent manner. At higher temperatures (e.g. approximately +37 °C (+98 °F)) the device may for small periods of time alternately enable and disable battery charging to keep the battery at acceptable temperatures. The device indicates when charging is disabled due to abnormal temperatures via its LED.

Vehicle Cradle

Refer to the *TC75 Integrator Guide* for information on installing the Vehicle Cradle.

The cradle:

- holds the TC75 securely in place
- provides power for operating the TC75
- re-charges the battery in the TC75.

The cradle is powered by the vehicle's 12V or 24V electrical system. The operating voltage range is 9V to 32V and supplies a maximum current of 3A.

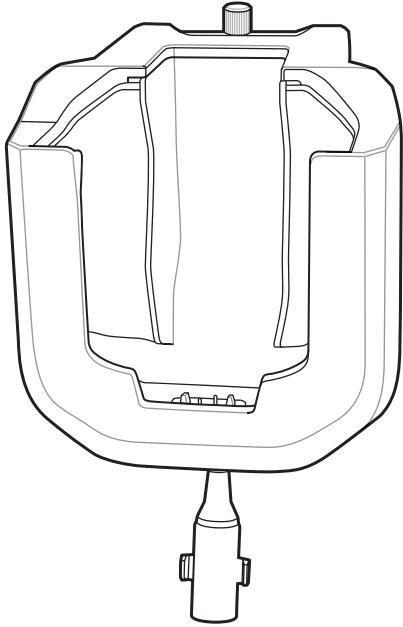
Figure 179: Vehicle Cradle**TC75 Insertion and Removal**

Caution: Ensure that the TC75 is fully inserted into the cradle. Lack of proper insertion may result in property damage or personal injury. Zebra Technologies Corporation is not responsible for any loss resulting from the use of the products while driving.

To ensure the TC75 was inserted correctly, listen for the audible click that signifies that the TC75 locking mechanism was enabled and the TC75 was locked into place.

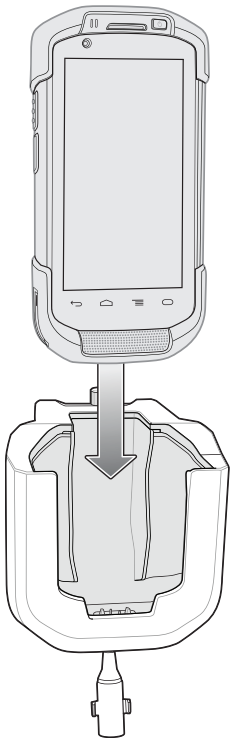
Figure 180: Install TC75 into Vehicle Cradle

To remove the TC75 from the cradle, grasp the TC75 and lift out of the cradle.

Figure 181: Remove TC75 from Vehicle Cradle

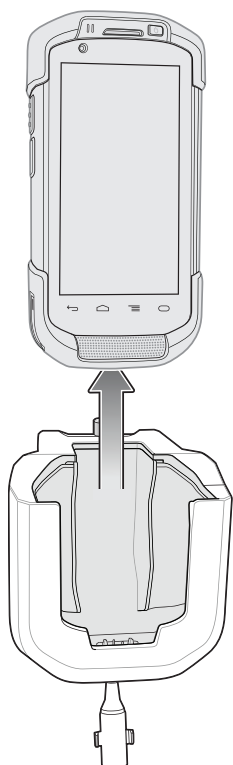

Battery Charging

Ensure the cradle is connected to a power source.

Insert the TC75 into the cradle. The TC75 starts to charge through the cradle as soon as it is inserted. This does not deplete the vehicle battery significantly. The battery charges in approximately four hours.



Note: The Vehicle Cradle operating temperature is $-40\text{ }^{\circ}\text{C}$ to $+85\text{ }^{\circ}\text{C}$. When in the cradle, the TC75 will only charge when its temperature is between $0\text{ }^{\circ}\text{C}$ to $+40\text{ }^{\circ}\text{C}$.

Table 20: LED Indicators

LED	Indication
TC75 Battery Charging (LED is on TC75)	
Off	TC75 is not in cradle, TC75 is not placed correctly, or cradle is not powered.
Fast Blinking Red (twice a second)	Error in charging (not within battery charging temperature or charging for too long without completion). Check placement of TC75.
Slow Blinking Amber (once every two seconds)	TC75 is charging.
Solid Green	Charging is complete.

Chapter

8

Maintenance and Troubleshooting

This chapter includes instructions on cleaning and storing the device, and provides troubleshooting solutions for potential problems during operation.

Maintaining the TC75

For trouble-free service, observe the following tips when using the TC75:

- Do not scratch the screen of the TC75. When working with the TC75, use the supplied stylus or plastic-tipped pens intended for use with a touch-sensitive screen. Never use an actual pen or pencil or other sharp object on the surface of the TC75 screen.
- The touch-sensitive screen of the TC75 is glass. Do not drop the TC75 or subject it to strong impact.
- Protect the TC75 from temperature extremes. Do not leave it on the dashboard of a car on a hot day, and keep it away from heat sources.
- Do not store or use the TC75 in any location that is dusty, damp, or wet.
- Use a soft lens cloth to clean the TC75. If the surface of the TC75 screen becomes soiled, clean it with a soft cloth moistened with a diluted window-cleaning solution.
- Periodically replace the rechargeable battery to ensure maximum battery life and product performance. Battery life depends on individual usage patterns.

Battery Safety Guidelines

- The area in which the units are charged should be clear of debris and combustible materials or chemicals. Particular care should be taken where the device is charged in a non commercial environment.
- Follow battery usage, storage, and charging guidelines found in this guide.
- Improper battery use may result in a fire, explosion, or other hazard.
- To charge the mobile device battery, the battery and charger temperatures must be between +32 °F and +104 °F (0 °C and +40 °C)
- Do not use incompatible batteries and chargers. Use of an incompatible battery or charger may present a risk of fire, explosion, leakage, or other hazard. If you have any questions about the compatibility of a battery or a charger, contact the Global Customer Support Center.
- For devices that utilize a USB port as a charging source, the device shall only be connected to products that bear the USB-IF logo or have completed the USB-IF compliance program.
- Do not disassemble or open, crush, bend or deform, puncture, or shred.
- Severe impact from dropping any battery-operated device on a hard surface could cause the battery to overheat.
- Do not short circuit a battery or allow metallic or conductive objects to contact the battery terminals.
- Do not modify or remanufacture, attempt to insert foreign objects into the battery, immerse or expose to water or other liquids, or expose to fire, explosion, or other hazard.
- Do not leave or store the equipment in or near areas that might get very hot, such as in a parked vehicle or near a radiator or other heat source. Do not place battery into a microwave oven or dryer.

- Battery usage by children should be supervised.
- Please follow local regulations to properly dispose of used re-chargeable batteries.
- Do not dispose of batteries in fire.
- In the event of a battery leak, do not allow the liquid to come in contact with the skin or eyes. If contact has been made, wash the affected area with large amounts of water and seek medical advice.
- If you suspect damage to your equipment or battery, contact the Customer Support to arrange for inspection.

Cleaning Instructions

**Caution:**

Always wear eye protection.

Read warning label on compressed air and alcohol product before using.

If you have to use any other solution for medical reasons please contact the Global Customer Support Center for more information.



Warning: Avoid exposing this product to contact with hot oil or other flammable liquids. If such exposure occurs, unplug the device and clean the product immediately in accordance with these guidelines.

Approved Cleanser Active Ingredients

100% of the active ingredients in any cleaner must consist of one or some combination of the following: isopropyl alcohol, bleach/sodium hypochlorite, hydrogen peroxide or mild dish soap.

Harmful Ingredients

The following chemicals are known to damage the plastics on the device and should not come in contact with the device: ammonia solutions, compounds of amines or ammonia; acetone; ketones; ethers; aromatic and chlorinated hydrocarbons; aqueous or alcoholic alkaline solutions; ethanolamine; toluene; trichloroethylene; benzene; carbolic acid and TB-lysoform.

Cleaning Instructions

Do not apply liquid directly to the device. Dampen a soft cloth or use pre-moistened wipes. Do not wrap the device in the cloth or wipe, but gently wipe the unit. Be careful not to let liquid pool around the display window or other places. Allow the unit to air dry before use.

Special Cleaning Notes

Many vinyl gloves contain phthalate additives, which are often not recommended for medical use and are known to be harmful to the housing of the device. The device should not be handled while wearing vinyl gloves containing phthalates, or before hands are washed to remove contaminant residue after gloves are removed. If products containing any of the harmful ingredients listed above are used prior to handling the device, such as hand sanitizer that contain ethanolamine, hands must be completely dry before handling the device to prevent damage to the plastics.

Cleaning Materials Required

- Alcohol wipes
- Lens tissue
- Cotton-tipped applicators
- Isopropyl alcohol
- Can of compressed air with a tube.

Cleaning Frequency

The cleaning frequency is up to the customer's discretion due to the varied environments in which the mobile devices are used. They may be cleaned as frequently as required, but it is advisable to clean the camera window periodically when used in dirty environments to ensure optimum performance.

Cleaning the TC75

Housing

Using the alcohol wipes, wipe the housing including buttons.

Display

The display can be wiped down with the alcohol wipes, but care should be taken not to allow any pooling of liquid around the edges of the display. Immediately dry the display with a soft, non-abrasive cloth to prevent streaking.

Camera and Exit Window

Wipe the camera and exit window periodically with a lens tissue or other material suitable for cleaning optical material such as eyeglasses.

Connector Cleaning

To clean the connectors:

Procedure:

- 1 Remove the main battery from mobile computer.
- 2 Dip the cotton portion of the cotton-tipped applicator in isopropyl alcohol.
- 3 Rub the cotton portion of the cotton-tipped applicator back-and-forth across the connector. Do not leave any cotton residue on the connector.
- 4 Repeat at least three times.
- 5 Use the cotton-tipped applicator dipped in alcohol to remove any grease and dirt near the connector area.
- 6 Use a dry cotton-tipped applicator and repeat steps 4 through 6.



Caution: Do not point nozzle at yourself and others, ensure the nozzle or tube is away from your face.

- 7 Spray compressed air on the connector area by pointing the tube/nozzle about ½ inch away from the surface.
- 8 Inspect the area for any grease or dirt, repeat if required.

Cleaning Cradle Connectors

To clean the connectors on a cradle:

Procedure:

- 1 Remove the DC power cable from the cradle.
- 2 Dip the cotton portion of the cotton-tipped applicator in isopropyl alcohol.
- 3 Rub the cotton portion of the cotton-tipped applicator along the pins of the connector. Slowly move the applicator back-and-forth from one side of the connector to the other. Do not leave any cotton residue on the connector.
- 4 All sides of the connector should also be rubbed with the cotton-tipped applicator.



Caution: Do not point nozzle at yourself and others, ensure the nozzle or tube is pointed away from your face.

- 5 Spray compressed air in the connector area by pointing the tube/nozzle about ½ inch away from the surface.
- 6 Remove any lint left by the cotton-tipped applicator.

- 7 If grease and other dirt can be found on other areas of the cradle, use a lint-free cloth and alcohol to remove.
- 8 Allow at least 10 to 30 minutes (depending on ambient temperature and humidity) for the alcohol to air dry before applying power to cradle.
If the temperature is low and humidity is high, longer drying time is required. Warm temperature and dry humidity requires less drying time.

Troubleshooting

The following tables provides typical problems that might arise and the solution for correcting the problem.

TC75

Table 21: Troubleshooting the TC75

Problem	Cause	Solution
When pressing the power button the TC75 does not turn on.	Battery not charged.	Charge or replace the battery in the TC75.
	Battery not installed properly.	Install the battery properly.
	System crash.	Perform a reset.
When pressing the power button the TC75 does not turn on but two LEDs blink.	Battery charge is at a level where data is maintained but battery should be recharged.	Charge or replace the battery in the TC75.
Battery did not charge.	Battery failed.	Replace battery. If the TC75 still does not operate, perform a reset.
	TC75 removed from cradle while battery was charging.	Insert TC75 in cradle. The 4,620 mAh battery fully charges in less than six hours at room temperature.
	Extreme battery temperature.	Battery does not charge if ambient temperature is below 0°C (32°F) or above 40°C (104°F).
Cannot see characters on display.	TC75 not powered on.	Press the Power button.
During data communication with a host computer, no data transmitted, or transmitted data was incomplete.	TC75 removed from cradle or disconnected from host computer during communication.	Replace the TC75 in the cradle, or reattach the communication cable and re-transmit.
	Incorrect cable configuration.	See the system administrator.
	Communication software was incorrectly installed or configured.	Perform setup.
During data communication over Wi-Fi, no data transmitted, or	Wi-Fi radio is not on.	Turn on the Wi-Fi radio.
	You moved out of range of an access point.	Move closer to an access point.

Table continued...



Problem	Cause	Solution
transmitted data was incomplete.		
During data communication over WAN, no data transmitted, or transmitted data was incomplete.	You are in an area of poor cellular service.	Move into an area that has better service.
	APN is not set up correctly.	See system administrator for APN setup information.
	SIM card not installed properly.	Remove and re-install the SIM card.
	Data plan not activated.	Contact your service provider and ensure that your data plan is enable.
During data communication over Bluetooth, no data transmitted, or transmitted data was incomplete.	Bluetooth radio is not on.	Turn on the Bluetooth radio.
	You moved out of range of another Bluetooth device.	Move within 10 meters (32.8 feet) of the other device.
No sound.	Volume setting is low or turned off.	Adjust the volume.
TC75 shuts off.	TC75 is inactive.	The display turns off after a period of inactivity. Set this period to 15 seconds, 30 seconds, 1, 2, 5, 10 or 30 minutes.
	Battery is depleted.	Replace the battery.
Tapping the window buttons or icons does not activate the corresponding feature.	The device is not responding.	Reset the device.
A message appears stating that the TC75 memory is full.	Too many files stored on the TC75.	Delete unused memos and records. If necessary, save these records on the host computer (or use an SD card for additional memory).
	Too many applications installed on the TC75.	Remove user-installed applications on the TC75 to recover memory. Select  >  Apps > Downloaded . Select the unused program and tap Remove .
The TC75 does not decode with reading bar code.	Scanning application is not loaded.	Load a scanning application on the TC75 or enable DataWedge. See the system administrator.
	Unreadable bar code.	Ensure the symbol is not defaced.
	Distance between exit window and bar code is incorrect.	Place the TC75 within proper scanning range.
	TC75 is not programmed for the bar code.	Program the TC75 to accept the type of bar code being scanned. Refer to the EMDK or DataWedge application.
	TC75 is not programmed to generate a beep.	If the TC75 does not beep on a good decode, set the application to generate a beep on good decode.
	Battery is low.	If the scanner stops emitting a laser beam upon a trigger press, check the battery level. When the battery is low, the scanner shuts off before the TC75 low battery condition notification.

Table continued...

Problem	Cause	Solution
TC75 cannot find any Bluetooth devices nearby.	Too far from other Bluetooth devices.	Note: If the scanner is still not reading symbols, contact the distributor or the Global Customer Support Center. Move closer to the other Bluetooth device(s), within a range of 10 meters (32.8 feet).
	The Bluetooth device(s) nearby are not turned on.	Turn on the Bluetooth device(s) to find.
	The Bluetooth device(s) are not in discoverable mode.	Set the Bluetooth device(s) to discoverable mode. If needed, refer to the device's user documentation for help.
Cannot unlock TC75.	User enters incorrect password.	If the user enters an incorrect password eight times, the user is requested to enter a code before trying again. If the user forgot the password, contact system administrator.

Chapter

9

Technical Specifications

The following sections provide technical specification for the device.

TC75

Table 22: TC75 Technical Specifications

Item	Description
Physical Characteristics	
Dimensions	Height: 161 mm (6.3 in.) Width: 84 mm (3.3 in.) Depth: 28 mm (1.1 in.)
Weight	376 g (13.3 oz)
Display	4.7 in. High Definition (1280 x 720); exceptionally bright image; optically bonded to touch panel with Gorilla Glass™ protection
Touch Panel	Capacitive touch
Backlight	Light Emitting Diode (LED) backlight
Battery Pack	Rechargeable Lithium Ion 3.7V, 4,620 mAh battery
Expansion Slot	User accessible microSD up to 32 GB SDHC and up to 64 GB SDXC support
Connection Interface	Universal Serial Bus (USB) 2.0 High Speed (host and client)
Notification	Audible tone plus multi-color LEDs, vibration
Voice and Audio	Three microphone support with noise cancellation; vibrate alert; speaker; Bluetooth wireless headset support. High quality speaker phone with up to 108 db SPL volume; PTT headset support; Cellular circuit switch voice; HD Voice
Performance Characteristics	
CPU	1.7 GHz dual-core.
Operating System	Android-based AOSP V4.4.3
Memory	1 GB RAM/8 GB Flash
Output Power	USB - 5 VDC @ 500 mA max
User Environment	

Table continued...

Item	Description
Operating Temperature	-20 °C to 50 °C (-4 °F to 122 °F)
Storage Temperature	-40°C to 70°C (-40°F to 158°F)
Charging Temperature	0° C to 40° C (32°F to 104°F)
Humidity	5 to 95% non-condensing
Drop Specification	8 ft./2.4 m to concrete at room temperature; 6 ft./1.8 m over the operating temperature range
Tumble	2,000 3.2 ft./1.0 m tumbles; meets and exceeds IEC tumble specifications
Electrostatic Discharge (ESD)	+/-15kVdc air discharge, +/-8kVdc direct discharge, +/-8kVdc indirect discharge
Sealing	IP67 per applicable IEC sealing specifications
Vibration	4 g's PK Sine (5 Hz to 2 kHz); 0.04g2/Hz Random (20 Hz to 2 kHz); 60 minute duration per axis, 3 axis
Thermal Shock	-40° C to 70° C (-40° F to 158° F) rapid transition
Interactive Sensor Technology (IST)	
Motion Sensor	3-axis accelerometer provides motion-sensing for dynamic screen orientation and power management
Light Sensor	Ambient light sensor to auto adjust display backlight brightness
Wireless WAN Data and Voice Communications	
Wireless Wide Area Network (WWAN) radio	TBS
Frequency band	<p>Worldwide:</p> <p>LTE: 800/850/900/1800/2100/2600 (FDD 20,5,8,3,1,7)</p> <p>UMTS/HSPA/HSPA+: 850/900/1900/2100</p> <p>GSM/GPRS/EDGE: 850/900/1800/1900</p> <p>Americas:</p> <p>LTE: 700/850/1900/AWS/2100 (FDD 17,5,2,4,1)</p> <p>UMTS/HSPA/HSPA+: 850, 900, AWS, 1900, 2100</p> <p>GSM/GPRS/EDGE: 850/900/1800/1900</p>
GPS	Integrated, Autonomous, Assisted GPS (A-GPS), Navstar, GLONASS
Wireless LAN Data and Voice Communications	
Radio	IEEE® 802.11a/b/g/n/d/h/i/k/r
Data Rates Supported	5GHz: 802.11a/n - up to 150 Mbps 2.4GHz: 802.11b/g/n - up to 72.2 Mbps
Operating Channels	5 GHz: Chan 36 - 165 (5180 - 5825 MHz) 2.4 GHz: Chan 1 - 11 (2412 – 2462 MHz) – North America (FCC and IC)

Table continued...

Item	Description
	Chan 1 - 13 (2412 - 2472 MHz) – Rest of the World Actual operating channels/frequencies depend on regulatory rules and certification agency
Security	Security Modes: Legacy, WPA and WPA2 Encryption: WEP (40 and 104 bit), TKIP and AES Authentication: TLS, TTLS (MS-CHAP), TTLS (MS-CHAP v2), TTLS (PAP), PEAP (MS-CHAP v2), PEAP (GTC), FAST (MS-CHAP v2), FAST (GTC), LEAP. Fast Roam: PMKID, OKC, CCKM
Voice Communications	Voice-over-IP ready, Wi-Fi™-certified, IEEE 802.11a/b/g/n direct sequence wireless LAN, Wi-Fi Multimedia™ (WMM)
Wireless PAN Data and Voice Communications	
Bluetooth	Bluetooth v4.0 Low Energy
Data Capture Specifications	
2D Imager	SE4750-SR – 1D and 2D bar codes.
Near Field Communications (NFC)	ISO 14443 Type A & B, FeliCa, and ISO 15963 cards. Secure NFC via SAM supporting Mifare, Calypso and FeliCa. P2P mode and Card Emulation via UICC and Host.
Communication and Messaging	
Workforce Connect PTT Express (included) for instant PTT calls between workers inside the four walls; Workforce Connect PTT Pro (supported) for PTT calls and text messaging over Wi-Fi and cellular networks; Workforce Connect Voice client (supported) to enable PBX handset functionality and more inside the four walls.	
2D Imager Engine (SE4750-SR) Specifications	
Field of View	Horizontal - 48.0° Vertical - 36.7°
Image Resolution	1280 horizontal X 960 vertical pixels
Roll	360°
Pitch Angle	+/- 60° from normal
Skew Tolerance	+/- 60° from normal
Ambient Light	Sunlight: 10,000 ft. candles (107,639 lux)
Focal Distance	From front of engine: 17.7 cm (7.0 in.)
Laser Aiming Element	Visible Laser Diode (VLD): 655 nm +/- 10 nm Central Dot Optical Power: 0.6 mW (typical) Pattern Angle: 48.0° horizontal, 38.0° vertical
Illumination System	LEDs: Warm white LED Pattern Angle: 80° at 505 intensity

Table continued...

Item	Description
Camera Specifications	
Resolution	Rear: 8 Mega pixel auto focus with flash Front: 1.3 Mega pixel fixed focus

Table 23: Data Capture Supported Symbologies

Item	Description
1D Bar Codes	Code 128, EAN-8, EAN-13, GS1 DataBar Expanded, GS1 128, GS1 DataBar Coupon, UP-CA, Interleaved 2 of 5, UPC Coupon Code
2D Bar Codes	PDF-417, QR Code



Zebra Technologies Corporation
3 Overlook Point
Lincolnshire IL, 60069 U.S.A.
<http://www.zebra.com>

Zebra and the stylized Zebra head are trademarks of ZIH Corp., registered in many jurisdictions worldwide. The Symbol logo is a registered trademark of Symbol Technologies, Inc., a Zebra Technologies company. All other trademarks are the property of their respective owners.
© 2015 Symbol Technologies LLC. All rights reserved.

